

VALVES FOR WINCHES

MBSN-300-AMSF

**SINGLE ACTING
WITH BRAKE RELEASE**

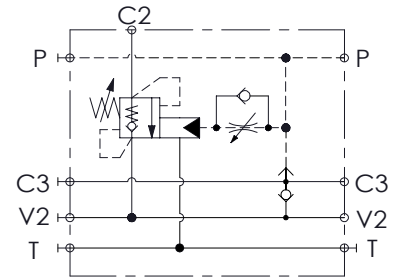
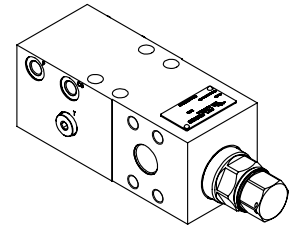
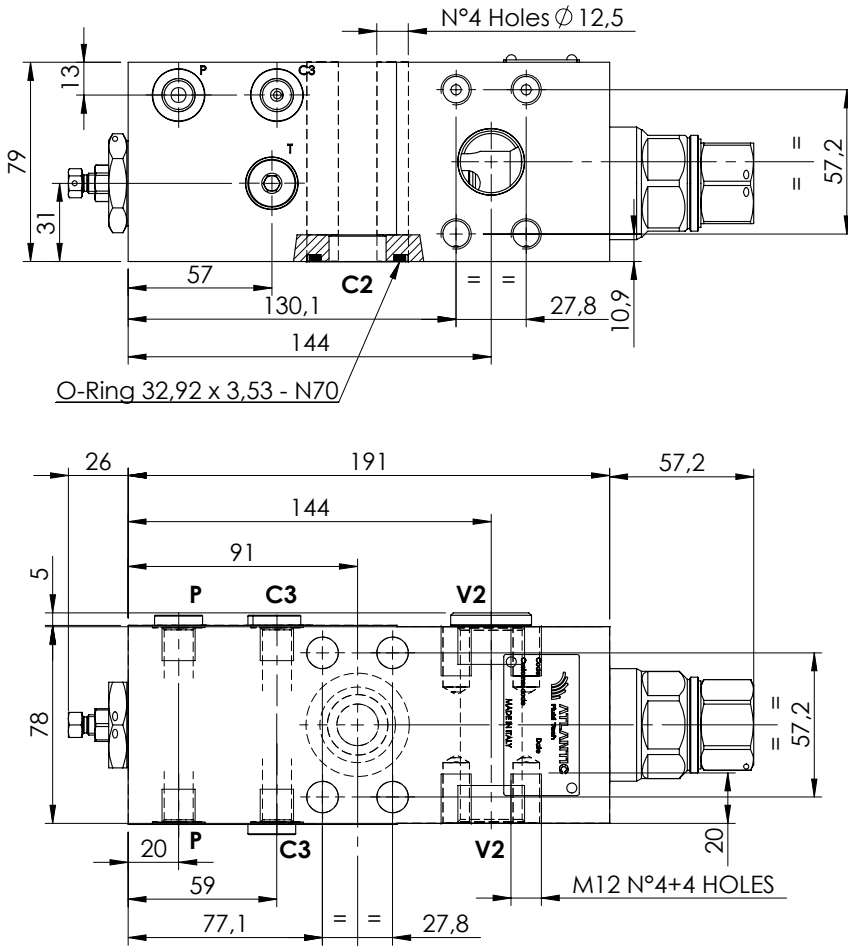

SPECIFICATIONS

Max. operating pressure:	500 bar
Rated flow:	300 l/min
Manifold:	Steel
Weight:	8 kg

NOTES

Setting: at least 1.3 times the load induced pressure

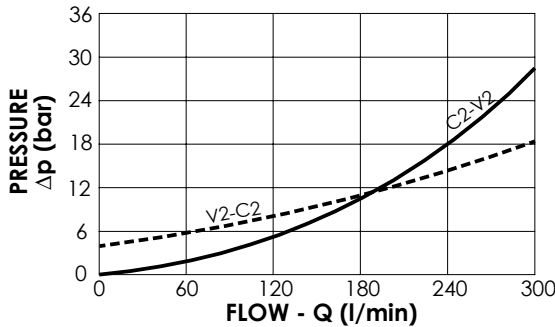

ORDERING CODES

Quick code	Description	Pilot ratio	Main ports size	Standard setting (bar, Q=5 l/min)	Adjust. range (bar)	Pressure increase (bar/turn)
MB000664	MBSN-300-AMSF-13-S10-N500	13:1	C2,V2 : 1" SAE 6000 P,C3 : G 1/4"	500	250-500	104