

VALVES FOR MOTORS

MBDN-300-AMSR OVERCENTRE WITH BRAKE RELEASE

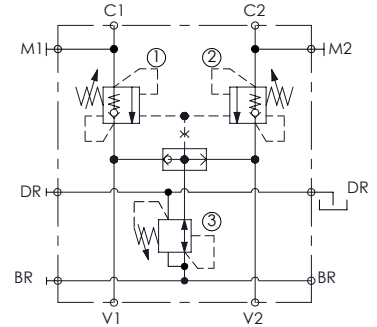
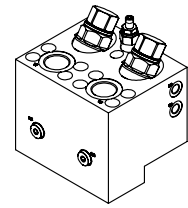
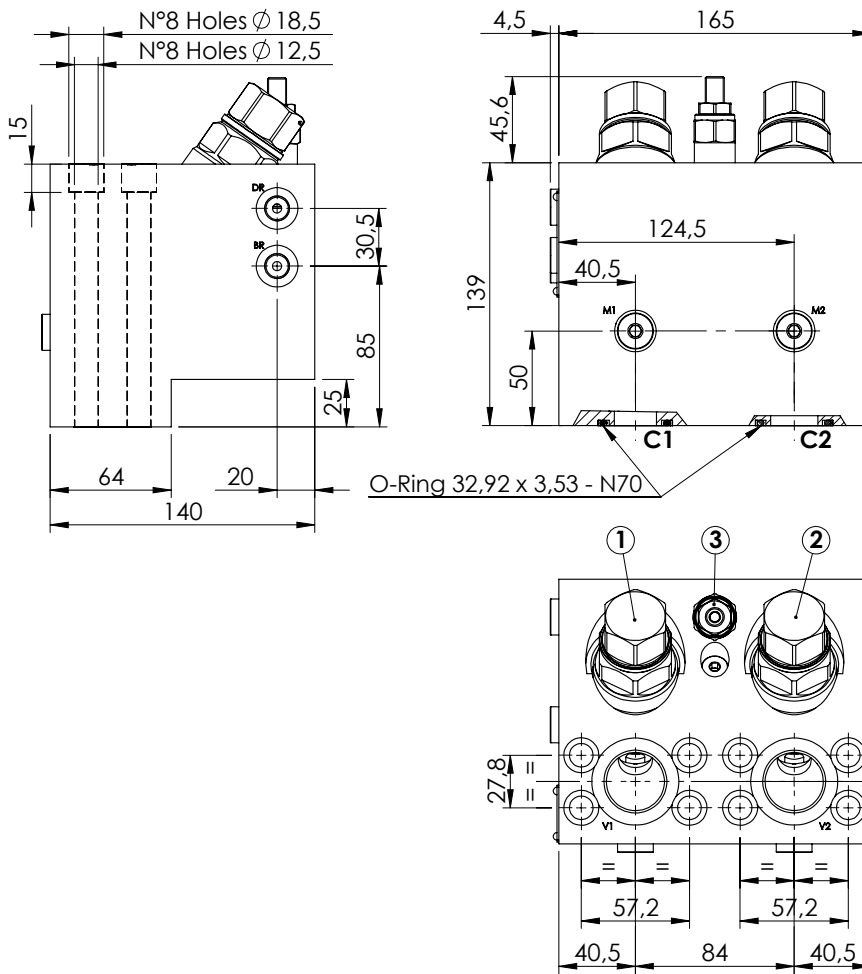

SPECIFICATIONS

Max. operating pressure:	420 bar
Rated flow:	300 l/min
Manifold:	Steel
Weight:	20,44 kg

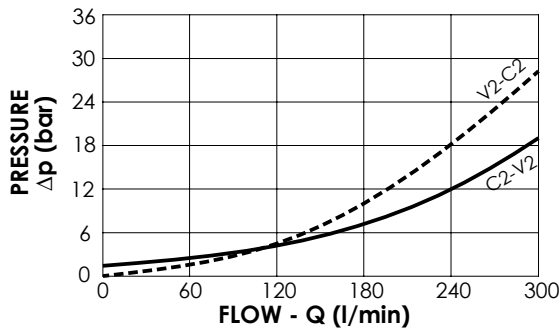

NOTES

Setting: at least 1.3 times the load induced pressure
 Designed for REXROTH A2FE 80-90 motors

ORDERING CODES

Quick code	Description	Pilot ratio	Main ports size	Standard setting (bar, Q=5 l/min)	Adjust. range (bar)	Pressure increase (bar/turn)
MB000402	MBDN-300-AMSR-04-S10-N420	4:1	V1,V2: G 1" C1,C2: 1" SAE 6000 BR,DR,M1,M2: G1/4"	①② : 350 ③ : 30	①②:100-350 ③: 10-60	①② : 75 ③ : 6
MB000349	MBDN-300-AMSR-06-S10-N420	6:1	V1,V2: G 1" C1,C2: 1" SAE 6000 BR,DR,M1,M2: G1/4"	①② : 380 ③ : 30	①②:100-420 ③: 10-60	①② : 62 ③ : 6