

VALVES FOR MOTORS

MFLN-300-RFSR

**FLUSHING VALVE
FLANGEABLE TYPE**

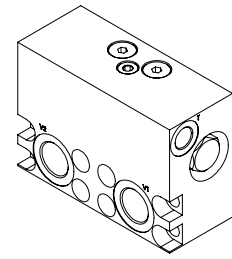

O-Ring 24,99x3,53 - N70

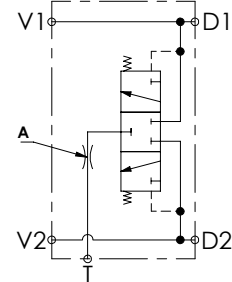
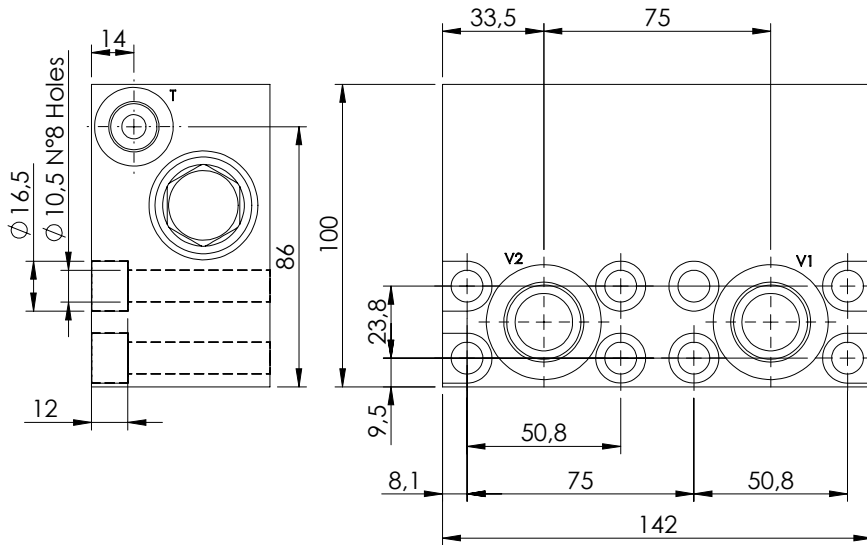

SPECIFICATIONS

Max. operating pressure:	420 bar
Rated flow:	300 l/min
Manifold:	Steel
Weight:	3,38 kg

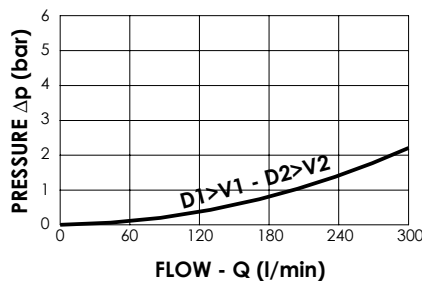
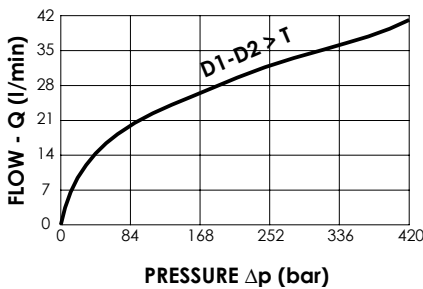

ORDERING CODES

Quick code	Description	Main ports size	Spool setting (bar)	A Orifice Ø	
MFO00110	MFLN-300-RFSR-09-S34-N420	V1,V2:G3/4" D1,D2:3/4"SAE 6000 T: G3/8"	6	1,9	