

OVERCENTRE VALVE

MBDN-150-ZLNP

DOUBLE ACTING

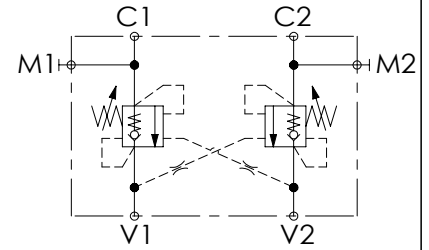
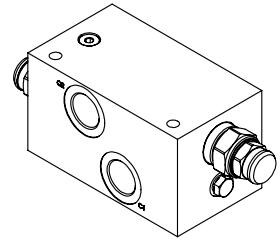
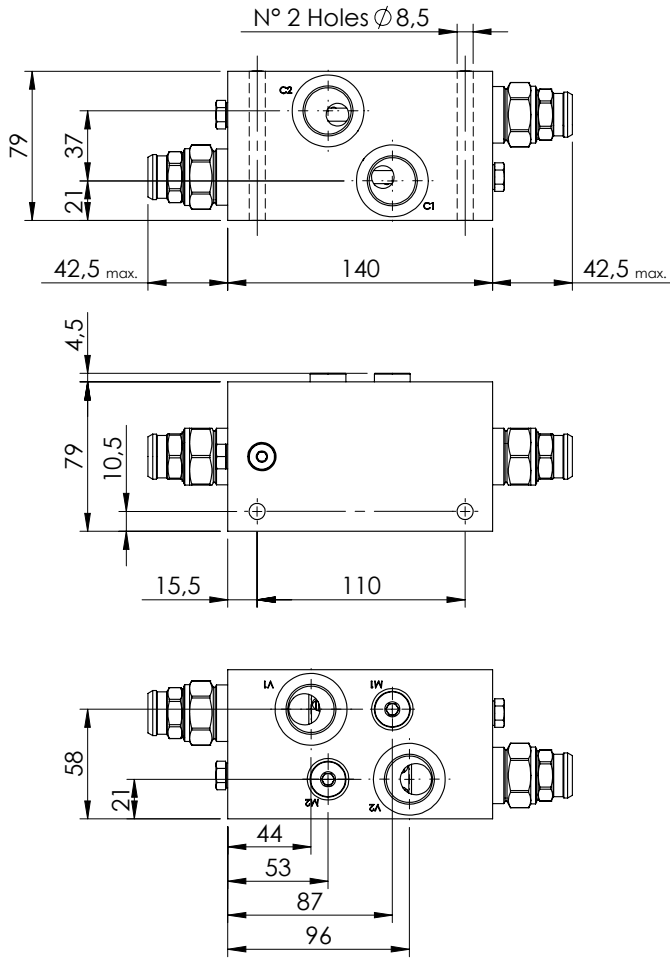

SPECIFICATIONS

Max. operating pressure:	350 bar
Rated flow:	150 l/min
Manifold:	Aluminium
Weight:	2,69 kg

SEALING CAP

Ordering code:
ST000012

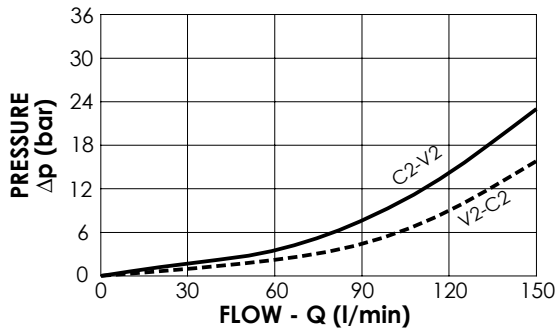
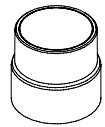

NOTES

Setting: at least 1.3 times the load induced pressure

ORDERING CODES

Quick code	Description	Pilot ratio	Main ports size	Standard setting (bar, Q=5 l/min)	Adjust. range (bar)	Pressure increase (bar/turn)
MB000210	MBDN-150-ZLNP-04-G34-N350	4:1	V1, V2: G3/4" C1, C2: G3/4"	350	100-350	104