

OVERCENTRE VALVE

MBSN-150-ABNV

SINGLE ACTING
TWO FLANGED PORTS

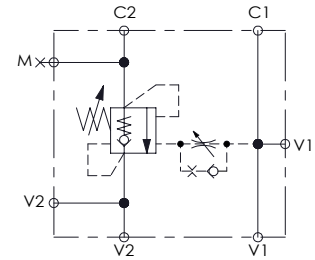
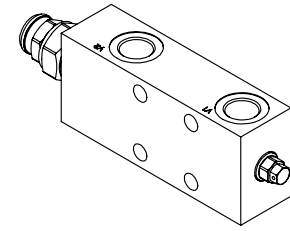
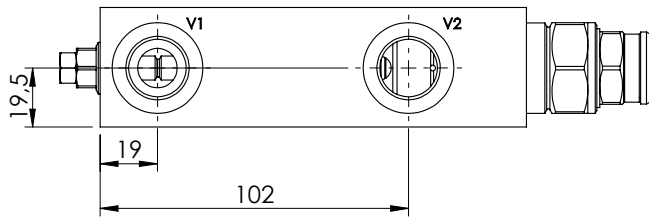
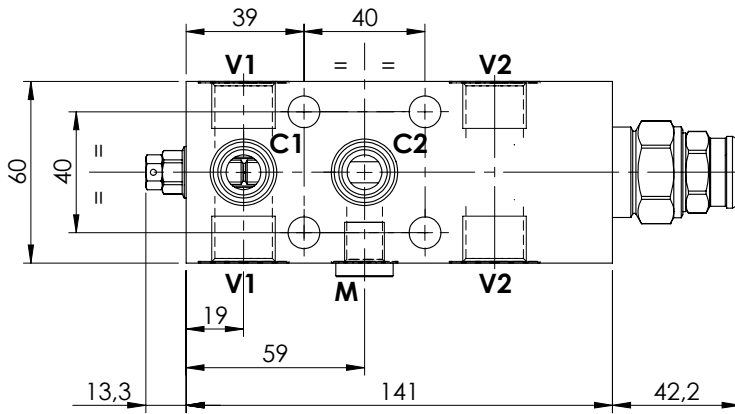
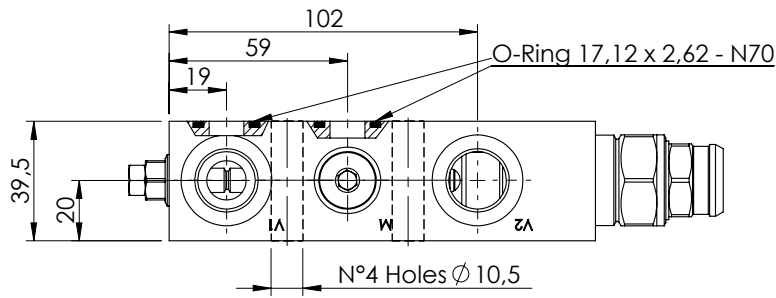

SPECIFICATIONS

Max. operating pressure:	350 bar
Rated flow:	150 l/min
Manifold:	Steel
Weight:	2,37 kg

SEALING CAP

Ordering code:
ST000012

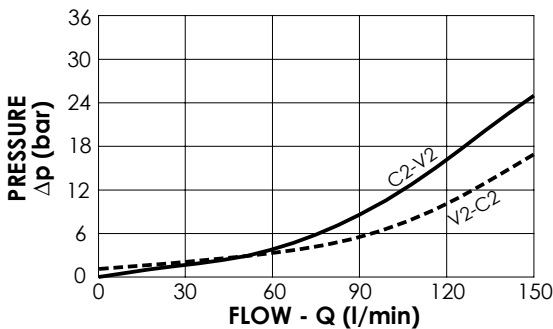
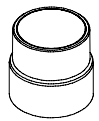

NOTES

Setting: at least 1.3 times the load induced pressure

ORDERING CODES

Quick code	Description	Pilot ratio	Main ports size	Standard setting (bar, Q=5 l/min)	Adjust. range (bar)	Pressure increase (bar/turn)
MB000156	MBSN-150-ABNV-04-G12-N350	4:1	V1, V2: G1/2" M:G1/4" C1, C2: Ø11.5	350	100-350	104
MB000883	MBSN-150-ABNV-08-G12-N350	8:1	V1, V2: G1/2" M:G1/4" C1, C2: Ø11.5	350	100-350	84