

OVERCENTRE VALVE

MBSN-150-ALNV

SINGLE ACTING

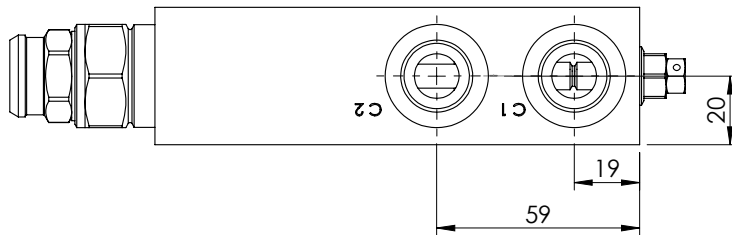
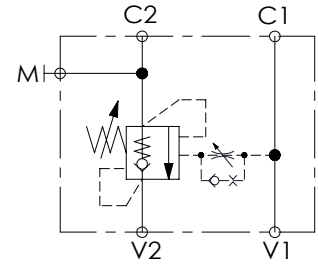
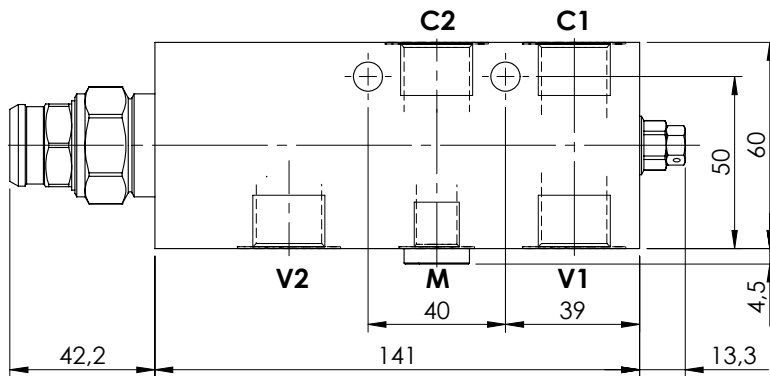
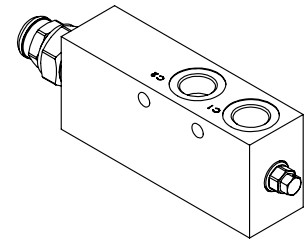
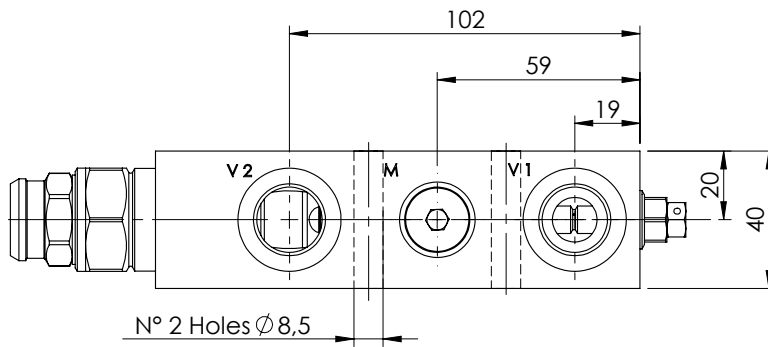

SPECIFICATIONS

Max. operating pressure:	350 bar
Rated flow:	150 l/min
Manifold:	Steel
Weight:	2,5 kg

SEALING CAP

Ordering code:
ST000012

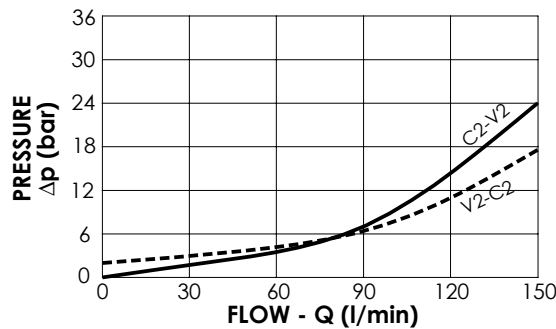
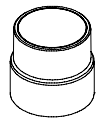

NOTES

Setting: at least 1.3 times the load induced pressure

ORDERING CODES

Quick code	Description	Pilot ratio	Main ports size	Standard setting (bar, Q=5 l/min)	Adjust. range (bar)	Pressure increase (bar/turn)
MB000047	MBSN-150-ALNV-04-G12-N350	4:1	V1, V2: G 1/2" M: G1/4" C1, C2: G1/2"	350	100-350	104