

**PRESSURE REDUCING IN BODY**

**KPRR-140-PNNR**

**PILOT OPERATED  
SPOOL TYPE**

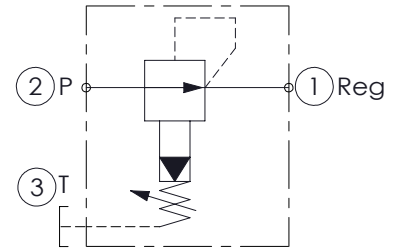
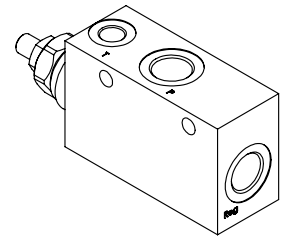
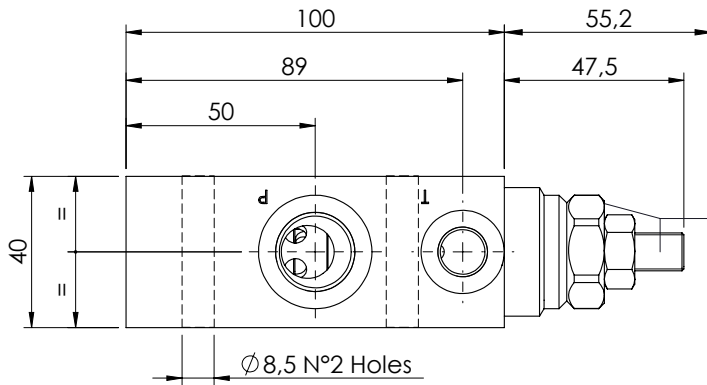
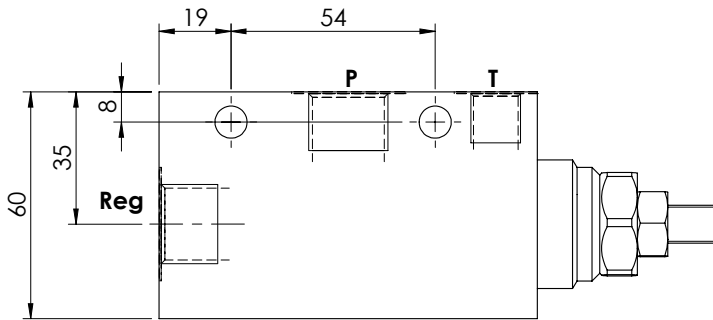

**SPECIFICATIONS**

Max. operating pressure:	250 bar
Rated flow:	140 l/min
Cavity:	SAE-12-3N
Weight:	0.8 kg
Manifold:	Aluminium

**SEALING CAP**

Ordering code:  
**AT000022**

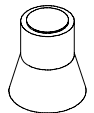

**OPTIONS**

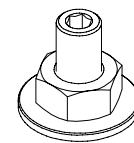

**Adjustment  
with Screw**

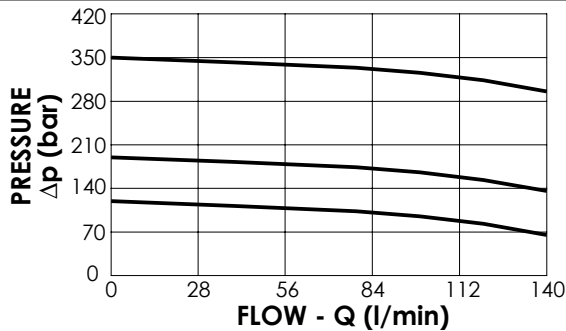

**ORDERING CODES**

Quick code	Description	Ports	Standard setting (bar)	Adjust. range (bar)	Pressure increase (bar/turn)	Options
KR000017	KPRR-140-PNNR-HN-G12-N350	P-Reg : G 1/2" T : G 1/4"	300	140-350	114	Adjustment with Screw
KR000019	KPRR-140-PNNR-HN-G12-N200	P-Reg : G 1/2" T : G 1/4"	200	70-210	69	Adjustment with Screw
KR000018	KPRR-140-PNNR-HN-G12-N100	P-Reg : G 1/2" T : G 1/4"	100	10-120	37	Adjustment with Screw