

SOLENOID OPERATED CARTRIDGE

CEBN-100-NAFN

**POPPET TYPE
PROXIMITY SENSOR**

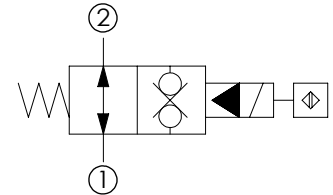
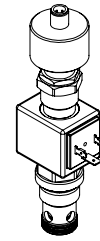
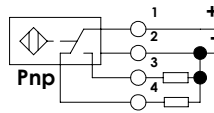
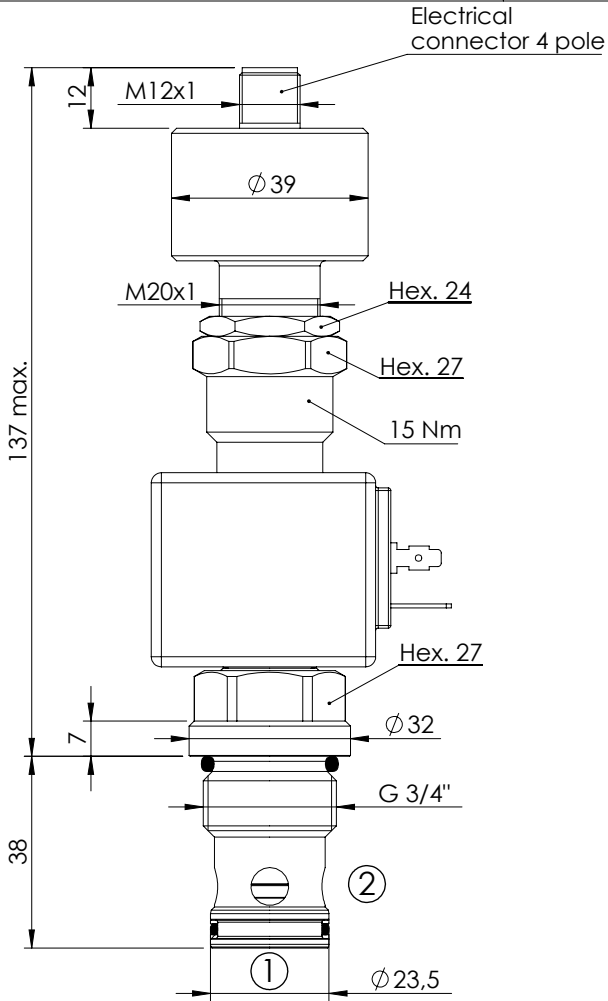

SPECIFICATIONS

Max. operating pressure:	350 bar
Rated flow:	100 l/min
Cavity:	VP000057
Weight:	0,6 kg
Coil type:	M7 type
Operating temperature:	-25/+80°C

NOTES

Installation torque:	110 - 130 Nm
Seal kit:	RD100057

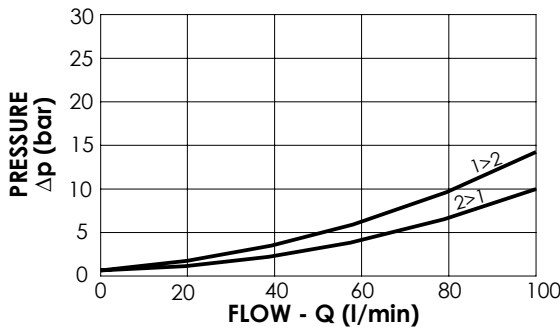

ORDERING CODES

Quick code	Description	Connector	Voltage	Options
CE001106	CEBN-100-NAFN-121-057-V350-12HR	DIN 43650	12V DC	Proximity sensor
CE001107	CEBN-100-NAFN-121-057-V350-24HR	DIN 43650	24V DC	Proximity sensor