

SOLENOID OPERATED CARTRIDGE

CEBN-040-NADR

**POPPET TYPE
PROXIMITY SENSOR**

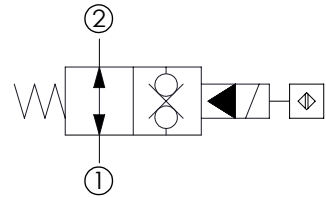
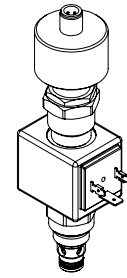
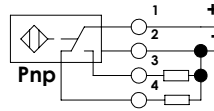
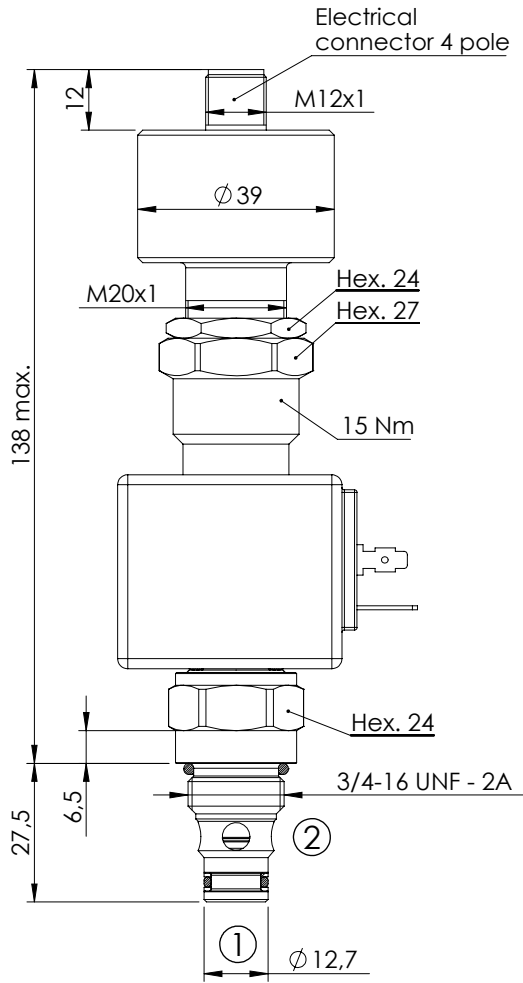

SPECIFICATIONS

Max. operating pressure:	350 bar
Rated flow:	40 l/min
Cavity:	SAE-08-2N
Weight:	0,5 kg
Coil type:	M7 type
Operating temperature:	-25/+80°C

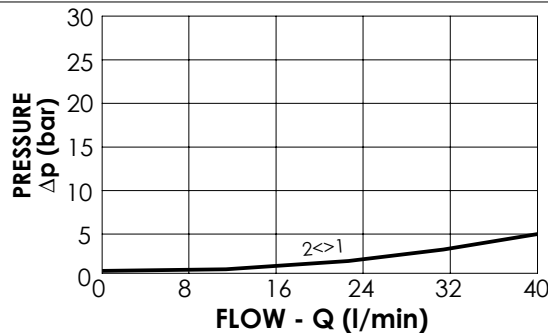

NOTES

Installation torque:	45 - 50 Nm
Seal kit:	RB100081

ORDERING CODES

Quick code	Description	Connector	Voltage	Options
CE001047	CEBN-040-NADR-121-S08-V350-12HR	DIN 43650	12V DC	Proximity sensor
CE001069	CEBN-040-NADR-121-S08-V350-24HR	DIN 43650	24V DC	Proximity sensor