

SOLENOID OPERATED CARTRIDGE

CEBN-070-NADR

**POPPET TYPE
PROXIMITY SENSOR**

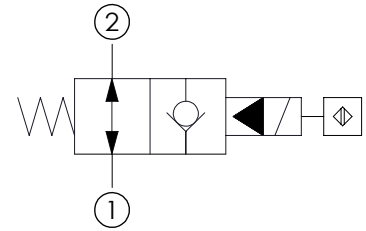
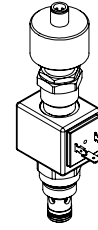
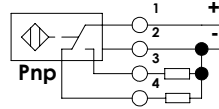
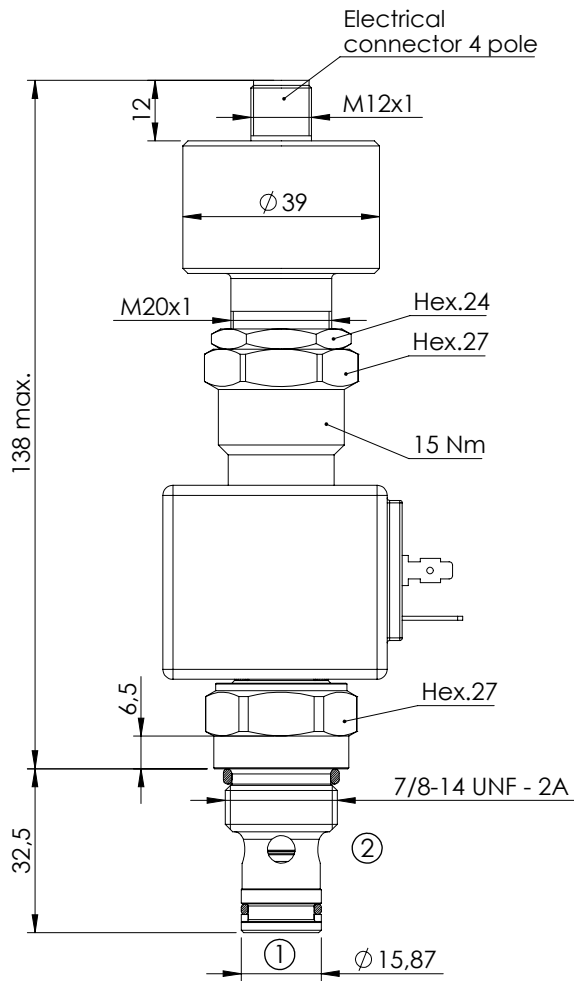

SPECIFICATIONS

Max. operating pressure:	350 bar
Rated flow:	70 l/min
Cavity:	SAE-10-2N
Weight:	0,5 kg
Coil type:	M7 type
Operating temperature:	-25/+80°C

NOTES

Installation torque:	55 - 62 Nm
Seal kit:	RA100082

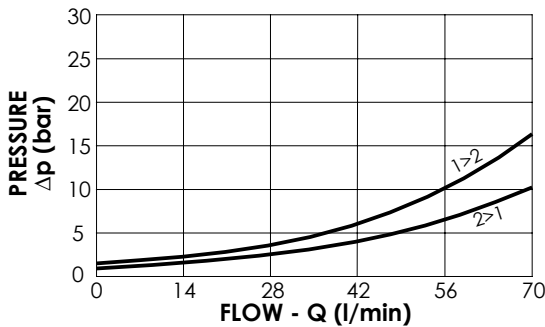

ORDERING CODES

Quick code	Description	Connector	Voltage	Options
CE001043	CEBN-070-NADR-101-S10-V350-12HR	DIN 43650	12V DC	Proximity sensor
CE001065	CEBN-070-NADR-101-S10-V350-24HR	DIN 43650	24V DC	Proximity sensor