

**SOLENOID OPERATED CARTRIDGE**

**CECS-010-SEFN**

**DIRECT OPERATED  
SPOOL TYPE**

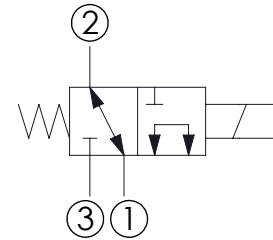
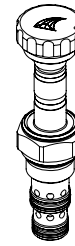
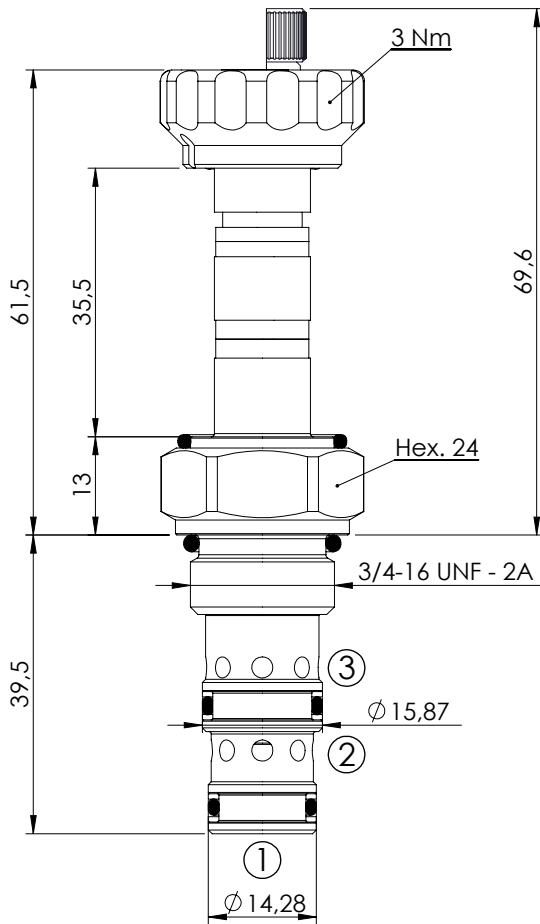

**SPECIFICATIONS**

Max. operating pressure:	210 bar
Rated flow:	10 l/min
Cavity:	SAE-08-3N
Weight:	0,14 kg
Min. voltage required:	90% of nominal
Coil type:	M7 type
Leakage:	120cm <sup>3</sup> /min
Seal kit:	RB700091

**NOTES**

Installation torque: 45 - 50 Nm

**OPTIONS**

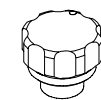

Standard

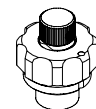

Knob style  
override

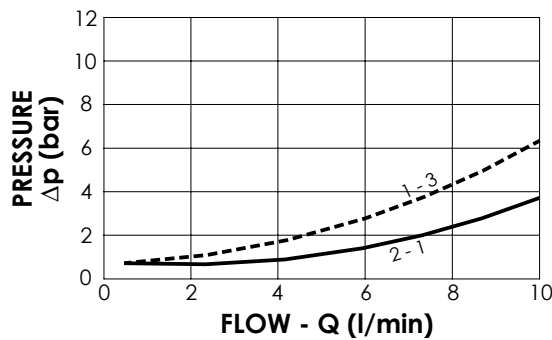

**ORDERING CODES**

Quick code	Description	Options	
CE000008	CECS-010-SEFN-64-S08-N210	Standard	
CE000070	CECS-010-SEFE-64-S08-N210	Knob style override	