

SOLENOID OPERATED CARTRIDGE

CEBN-100-NAFN

**PILOT OPERATED
POPPET TYPE**

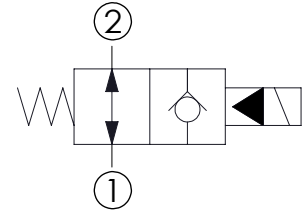
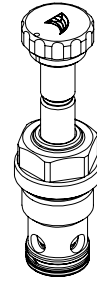
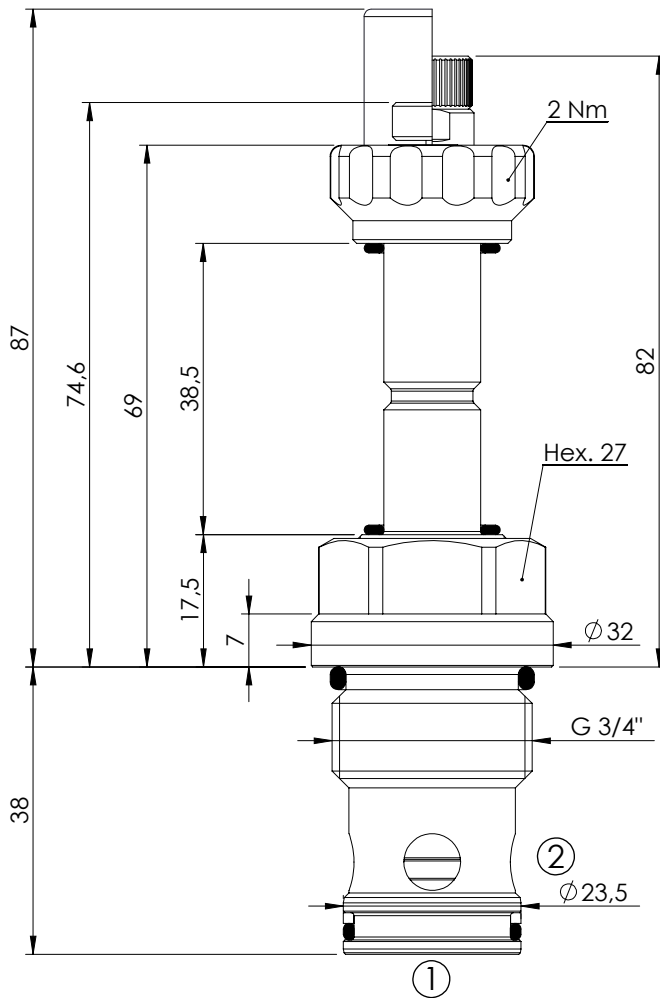

SPECIFICATIONS



Max. operating pressure:	350/500 bar
Rated flow:	100 l/min
Cavity:	VP000057
Weight:	0,25 kg
Min. voltage required:	90% of nominal
Coil type:	M7 type
Seal kit:	RC900057

NOTES

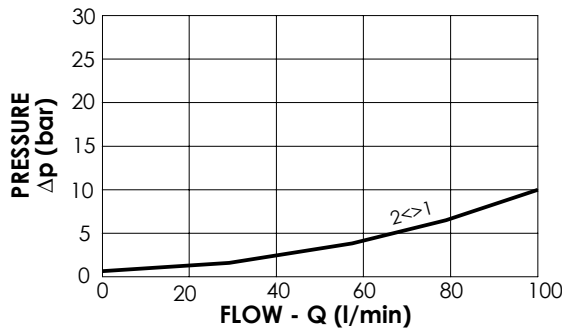
Installation torque: 110 - 130 Nm



OPTIONS

-  Standard
-  Push style override
-  Knob style override

SEALING CAP

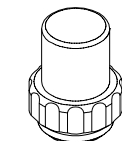

Ordering code:
AT000113

ORDERING CODES

Quick code	Description	Options	Max operating pressure (bar)
CE000303	CEBN-100-NAFN-04-057-N350	Standard	350
CE000304	CEBN-100-NAFP-04-057-N350	Push style override	350
CE000305	CEBN-100-NAFK-04-057-N350	Knob style override	350
CE000603	CEBN-100-NAFN-04-057-N500	Standard	500
CE000604	CEBN-100-NAFP-04-057-N500	Push style override	500
CE000605	CEBN-100-NAFK-04-057-N500	Knob style override	500