

SOLENOID OPERATED CARTRIDGE

CEBN-300-NAFN

**PILOT OPERATED
POPPET TYPE**

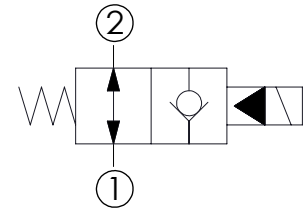
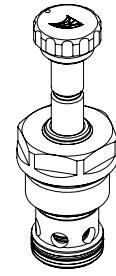
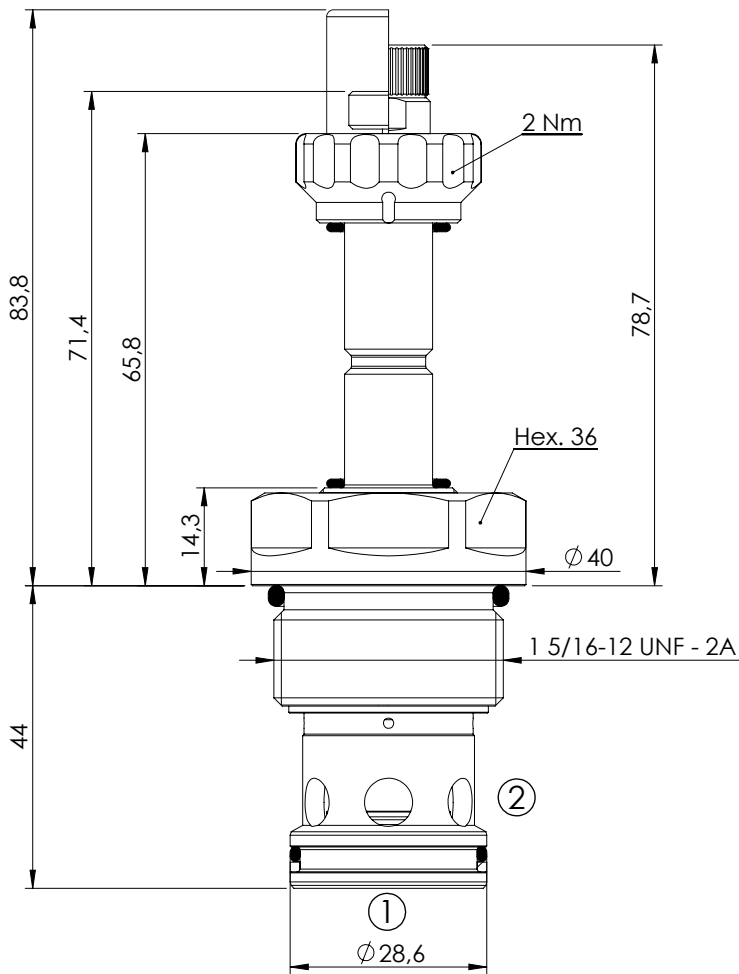

SPECIFICATIONS

Max. operating pressure:	350/500 bar
Rated flow:	300 l/min
Cavity:	SAE-16-2N
Weight:	0,36 kg
Min. voltage required:	90% of nominal
Coil type:	M7 type
Seal kit:	RA900084

NOTES

Installation torque: 118 - 132 Nm

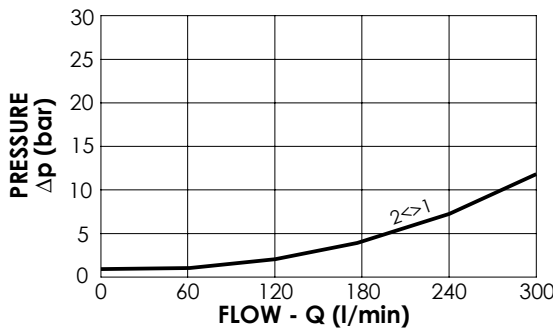

OPTIONS

- Standard
- Push style override
- Knob style override

SEALING CAP

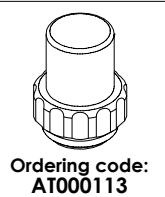

ORDERING CODES

Quick code	Description	Options	Max operating pressure (bar)
CE000411	CEBN-300-NAFN-06-S16-N350	Standard	350
CE000412	CEBN-300-NAFP-06-S16-N350	Push style override	350
CE000413	CEBN-300-NAFK-06-S16-N350	Knob style override	350
CE000711	CEBN-300-NAFN-06-S16-N500	Standard	500
CE000712	CEBN-300-NAFP-06-S16-N500	Push style override	500
CE000713	CEBN-300-NAFK-06-S16-N500	Knob style override	500