

SOLENOID OPERATED CARTRIDGE

CEBN-070-NAFN

**PILOT OPERATED
POPPET TYPE**

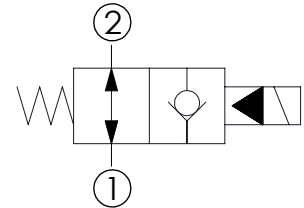
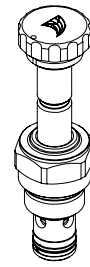
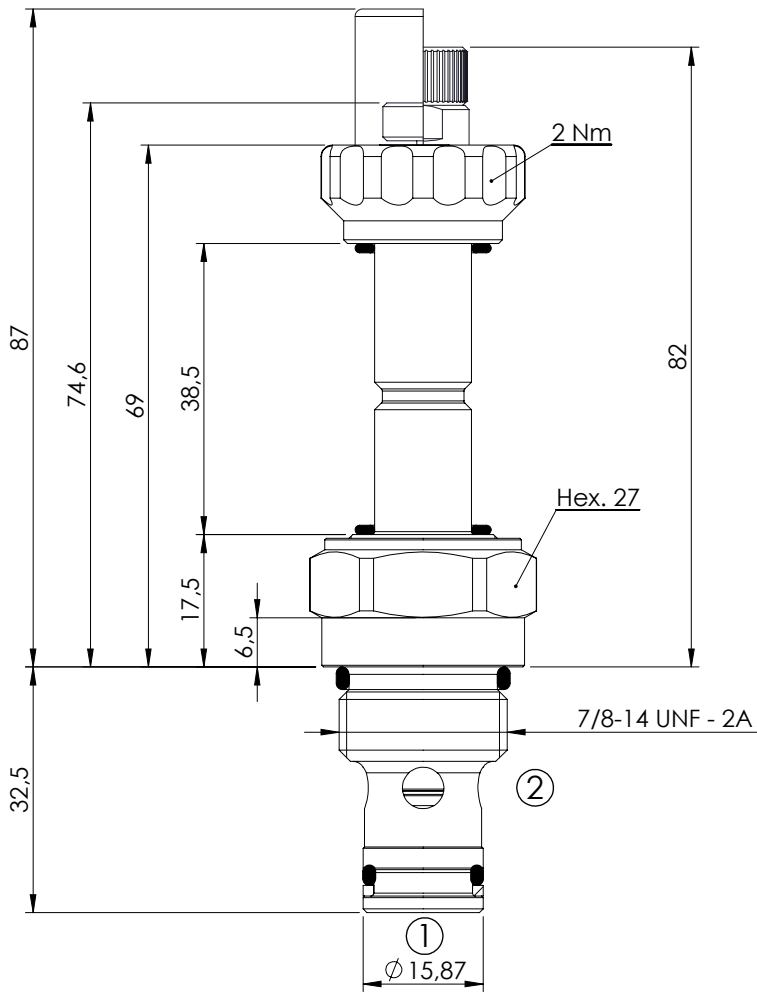

SPECIFICATIONS

Max. operating pressure:	350/500 bar
Rated flow:	70 l/min
Cavity:	SAE-10-2N
Weight:	0,18 kg
Min. voltage required:	90% of nominal
Coil type:	M7 type
Seal kit:	RA900082

NOTES

Installation torque: 55 - 62 Nm

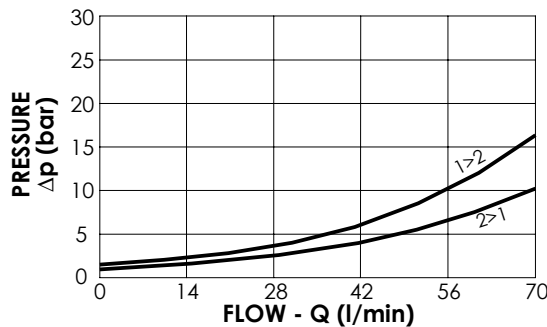

OPTIONS

- Standard
- Push style override
- Knob style override

SEALING CAP

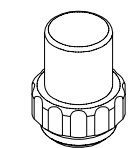

Ordering code:
AT000113

ORDERING CODES

Quick code	Description	Options	Max operating pressure (bar)
CE000271	CEBN-070-NAFN-06-S10-N350	Standard	350
CE000272	CEBN-070-NAFP-06-S10-N350	Push style override	350
CE000273	CEBN-070-NAFK-06-S10-N350	Knob style override	350
CE000571	CEBN-070-NAFN-06-S10-N500	Standard	500
CE000572	CEBN-070-NAFP-06-S10-N500	Push style override	500
CE000573	CEBN-070-NAFK-06-S10-N500	Knob style override	500