

SOLENOID OPERATED CARTRIDGE

CEBD-015-NCFN

**DIRECT OPERATED
POPPET TYPE**

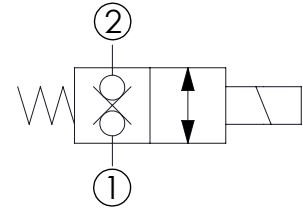
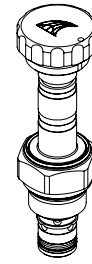
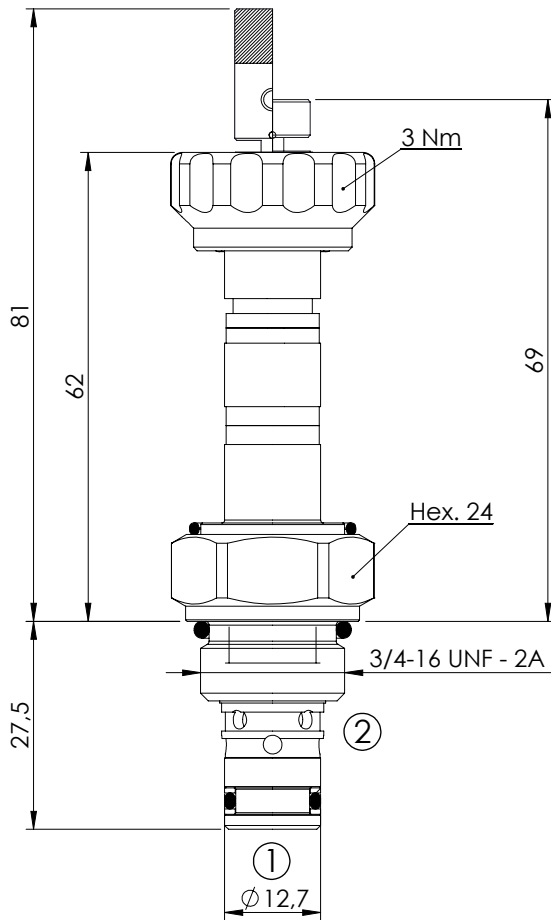

SPECIFICATIONS

Max. operating pressure:	210 bar
Rated flow:	15 l/min
Cavity:	SAE-08-2N
Weight:	0,12 kg
Min. voltage required:	90% of nominal
Coil type:	M7 type
Seal kit:	RB700081

NOTES

Installation torque: 45 - 50 Nm

OPTIONS

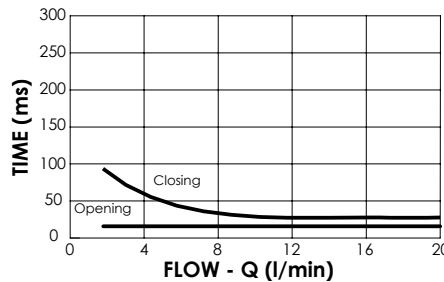
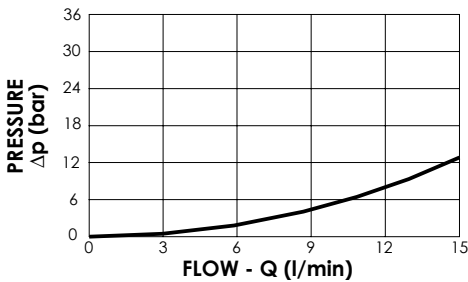
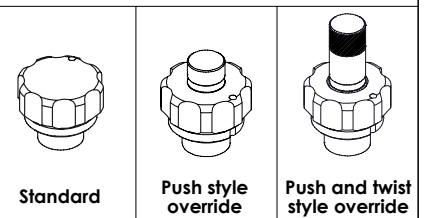

ORDERING CODES

Quick code	Description	Options
CE000062	CEBD-015-NCFN-21-S08-N210	Standard
CE000063	CEBD-015-NCFE-21-S08-N210	Push style override
CE000905	CEBD-015-NCFE-21-S08-N210-T	Push and twist style override