

SOLENOID OPERATED CARTRIDGE

CEBN-001-NAFN

**DIRECT OPERATED
POPPET TYPE**

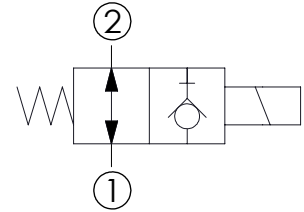
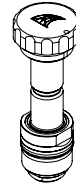
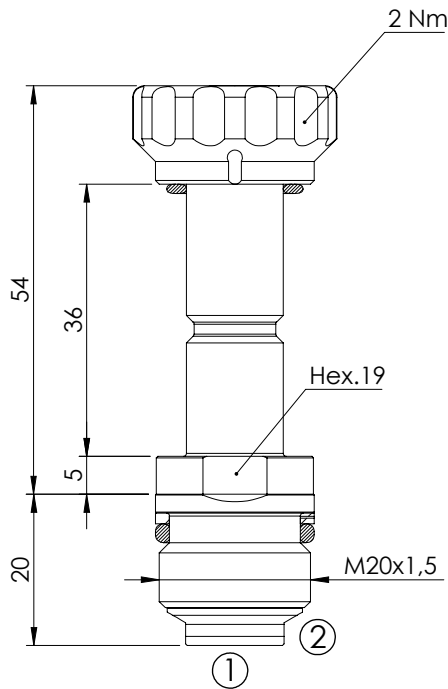

SPECIFICATIONS

Max. operating pressure:	350 bar
Rated flow:	1 l/min
Cavity:	VP000445
Weight:	0,1 kg
Min. voltage required:	90% of nominal
Coil type:	M7 type
Seal kit:	RC700445

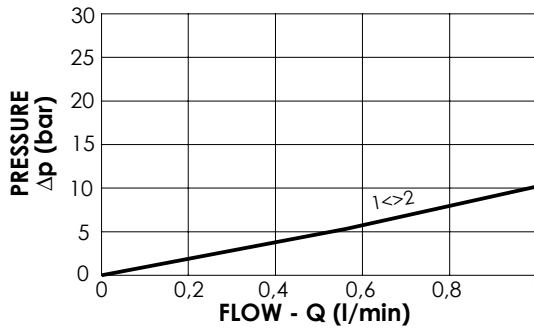

NOTES

Installation torque: 40 - 45 Nm

ORDERING CODES

Quick code	Description	Max operating pressure (bar)	
CE000873	CEBN-001-NAFN-14-445-N350	350	