

FLOW REGULATOR

CFPT-140-MVRR

**3 WAYS COMBINATION
ADJUSTABLE SETTING**

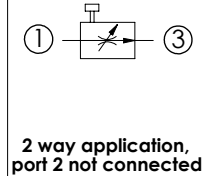
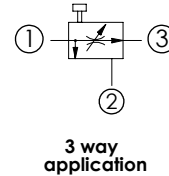
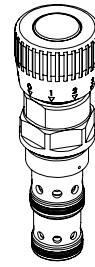
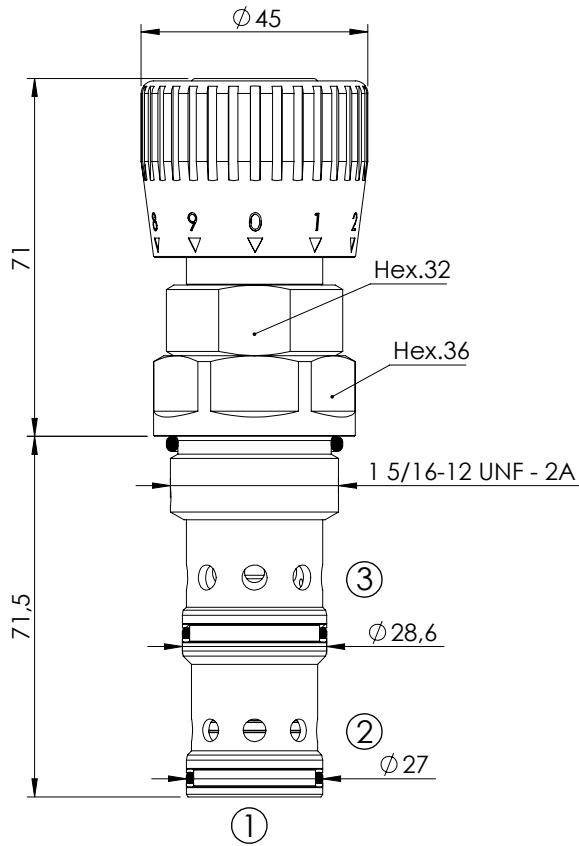

SPECIFICATIONS

Max. operating pressure:	350 bar
Division or combination:	140 l/min
Cavity:	SAE-16-3N
Weight:	0,7 kg
Seal kit:	RB700094

ADJUSTMENT TYPE

Graduated handknob for flow regulation under pressure

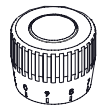

NOTES

Installation torque: 118 - 132 Nm

If port 2 is blocked the valve operates as a two way flow regulator. Port 2 can be pressurized.

The washer is used to indicate the zero.

Ordering code: SV000083

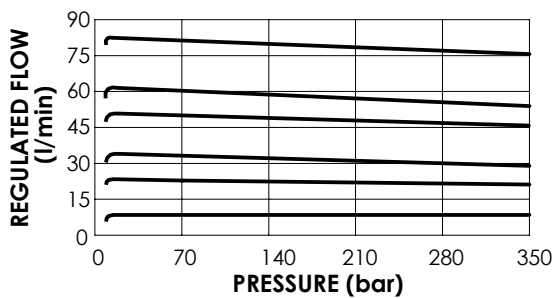
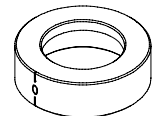

ORDERING CODES

Quick code	Description	Regulated flow range (l/min)	Adjustment option
CF000310	CFPT-140-MVRR-15-S16-N350	0 - 15	Graduated handknob
CF000311	CFPT-140-MVRR-25-S16-N350	0 - 25	Graduated handknob
CF000312	CFPT-140-MVRR-35-S16-N350	0 - 35	Graduated handknob
CF000313	CFPT-140-MVRR-50-S16-N350	0 - 50	Graduated handknob
CF000314	CFPT-140-MVRR-65-S16-N350	0 - 65	Graduated handknob
CF000315	CFPT-140-MVRR-80-S16-N350	0 - 80	Graduated handknob