

FLOW RESTRICTOR

CFSN-040-MHRR

**NEEDLE RESTRICTOR
FREE REVERSE FLOW**

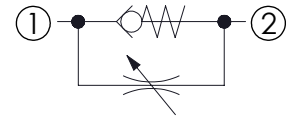
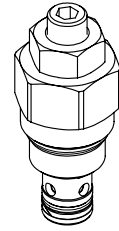
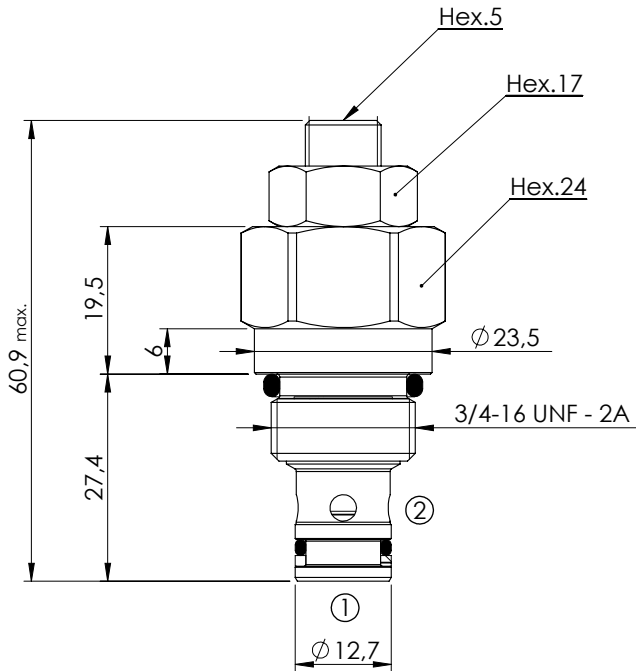

SPECIFICATIONS

Max. operating pressure:	350 bar
Rated Flow:	40 l/min
Material:	Steel
Cavity:	SAE-08-2N
Weight:	0,12 kg
Seal kit:	RA700081

NOTES

Installation torque: 45-50 Nm

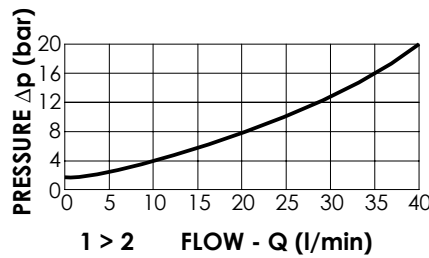
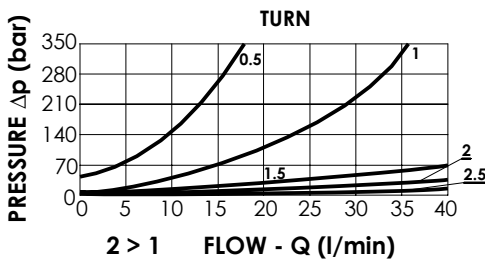

ADJUSTMENT OPTIONS

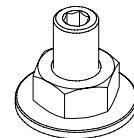

**Adjustment
with Screw**

ORDERING CODES

Quick code	Description	Options
CF000167	CFSN-040-MHRR-NP-S08-N350	Adjustment with Screw