







**ATLANTIC**  
Fluid Tech

**SECTION  
16**

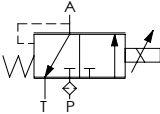
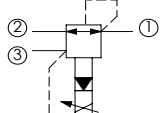
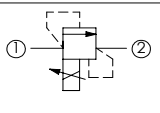
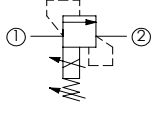
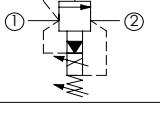
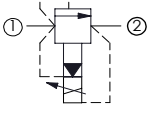
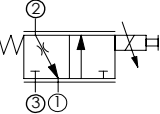
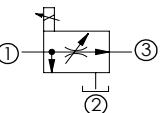
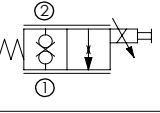
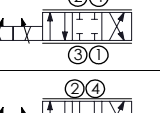
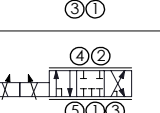
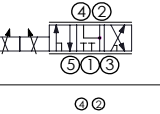
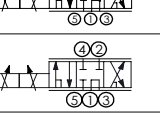
Proportional  
Cartridges

# PROPORTIONAL CARTRIDGES

Hydraulic scheme	Valve description	Valve type	Rated flow l/min (gpm)	Max. pressure bar (psi)	Installation	Main port size or cavity type	Page
	<a href="#">CECS-005-PRPN</a>	Proportional, direct operated, pressure reducing	5 (1,3)	50 (700)	DT04-2P	VP000371	16.010
	<a href="#">CECT-080-PRPS</a>	Proportional, pilot operated, reducing and relieving	80 (21)	250 (3600)	Cartridge	SAE-10-3N	16.020
	<a href="#">CEBD-005-PLPS</a>	Proportional, poppet type relief	5 (1,3)	350 (5000)	Cartridge	SAE-08-2N	16.030
	<a href="#">CEBD-001-PMPS</a>	Proportional, poppet type relief, for inverse controlled	0,6 (0,1)	350 (5000)	Cartridge	SAE-08-2N	16.040
	<a href="#">CEBT-120-PMPS</a>	Proportional, pilot operated, relieving, for fan drive	120 (32)	350 (5000)	Cartridge	SAE-10-2N	16.050
	<a href="#">CEBT-120-PLPS</a>	Proportional, pilot operated, relieving	120 (32)	350 (5000)	Cartridge	SAE-10-2N	16.060
	<a href="#">CEBT-300-PLPS</a>	Proportional, pilot operated, relieving	300 (79)	350 (5000)	Cartridge	SAE-16-2N	16.070
	<a href="#">CEBT-500-PLPS</a>	Proportional, pilot operated, relieving	500 (132)	350 (5000)	Cartridge	SAE-20-2N	16.080
	<a href="#">CECS-020-FSPS</a>	Proportional, non compensated, flow regulator	20 (5)	210 (3000)	Cartridge	SAE-10-3N	16.090
	<a href="#">CECS-030-FSPS</a>	Proportional, non compensated, flow regulator	30 (8)	210 (3000)	Cartridge	SAE-10-3N	16.090
	<a href="#">CECS-040-FSPS</a>	Proportional, non compensated, flow regulator	40 (11)	210 (3000)	Cartridge	SAE-10-3N	16.090
	<a href="#">CECS-050-FRPM</a>	Proportional, direct operated, flow regulator	50 (13)	320 (4600)	Cartridge	SAE-10-3N	16.100
	<a href="#">CECS-140-FRPM</a>	Proportional, direct operated, flow regulator	140 (37)	320 (4600)	Cartridge	SAE-16-3N	16.110
	<a href="#">CEBD-020-PEPS</a>	Proportional, normally closed	20 (5)	210 (3000)	Cartridge	SAE-08-2N	16.120
	<a href="#">CEBD-020-PEPS</a>	Proportional, normally closed	20 (5)	210 (3000)	Cartridge	VP000064	16.130
	<a href="#">CEES-010-SEPN</a>	Proportional, direct operated	10 (3)	350 (5000)	Cartridge	SAE-08-4N	16.140
	<a href="#">CEES-030-SEFN</a>	Proportional, direct operated	30 (8)	350 (5000)	Cartridge	SAE-10-4N	16.190
	<a href="#">CEES-010-SEPN</a>	Proportional, direct operated	10 (3)	350 (5000)	Cartridge	SAE-08-4N	16.150
	<a href="#">CEES-030-SEPN</a>	Proportional, direct operated	30 (8)	350 (5000)	Cartridge	SAE-10-4N	16.200
	<a href="#">CEFS-010-SEPN</a>	Proportional, direct operated	10 (3)	350 (5000)	Cartridge	SAE-08-5N	16.160
	<a href="#">CEFS-030-SEFN</a>	Proportional, direct operated	30 (8)	350 (5000)	Cartridge	SAE-10-5N	16.210
	<a href="#">CEFS-010-SEPN</a>	Proportional, direct operated	10 (3)	350 (5000)	Cartridge	SAE-08-5N	16.170
	<a href="#">CEFS-030-SEPN</a>	Proportional, direct operated	30 (8)	350 (5000)	Cartridge	SAE-10-5N	16.220
	<a href="#">CEFS-010-SEPN</a>	Proportional, direct operated	10 (3)	350 (5000)	Cartridge	SAE-08-5N	16.180
	<a href="#">CEFS-030-SEFN</a>	Proportional, direct operated	30 (8)	350 (5000)	Cartridge	SAE-10-5N	16.230
	<a href="#">ELPC-030-SCCB</a>	Proportional electronic controller	-	-	DIN 43650	-	16.240

SOLENOID OPERATED CARTRIDGE

# CECS-005-PRPN

PROPORTIONAL VALVES  
DIRECT OPERATED  
PRESSURE REDUCING

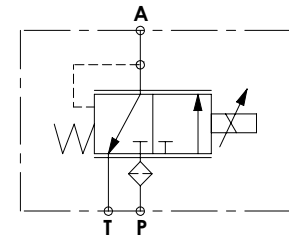
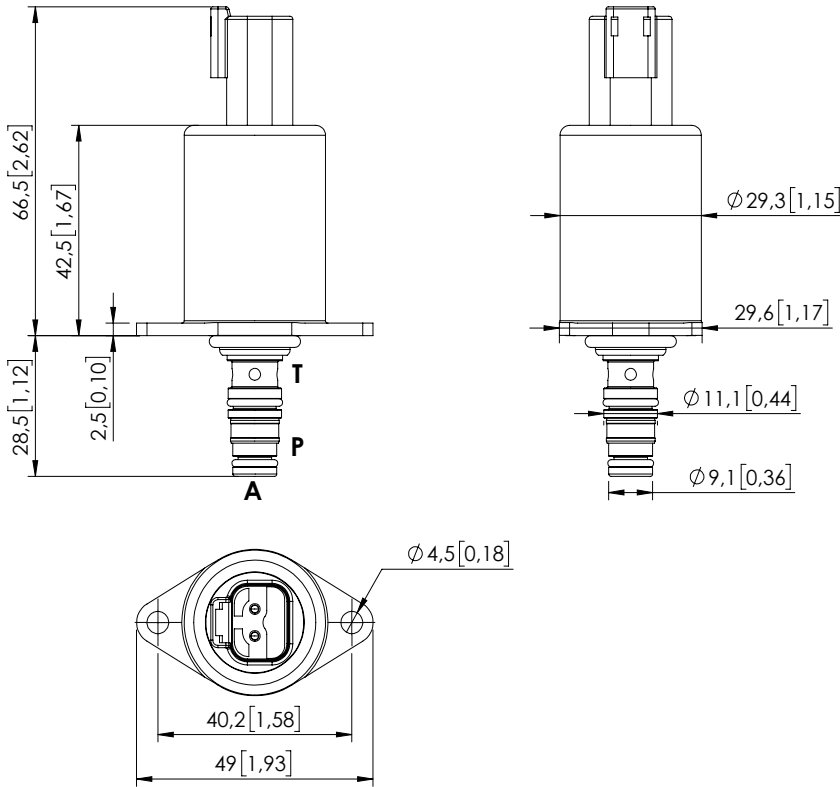

### SPECIFICATIONS

Max. P pressure:	50 bar (700 psi)
Max. T pressure:	30 bar (400 psi)
Rated flow:	5 l/min (1,3 gpm)
Cavity:	VP000371
Weight:	0,2 kg (0,44 lbs)
Connector type:	Deutsch DT04-2P
Internal leakage:	15 cc/min @ 25 bar, 46 cSt (0,9 in <sup>3</sup> /min @ 363 psi, 46 cSt)
Protection class:	Up to IP6K6 / IPX9K
PWM range recommended:	100 Hz
Seal kit:	RC100371
Mounting screw torque:	3,5 Nm (2,5 ft-lb)
MTF <sub>a</sub> :	150 - 1200 years: See technical spec.
Filter on P port:	125 $\mu$ m

### NOTES

Mounting screw not included  
 Mounting screw: 2 x M4x10 [M4x0,39] class 8.8  
 For other configurations/quick codes not available in this catalogue page please consult factory

### CURVES

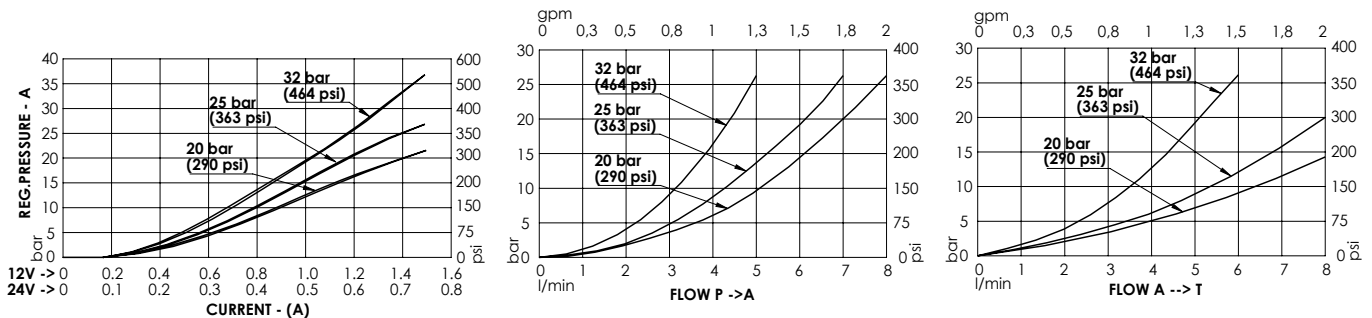

### ORDERING CODES

Quick code	Description	Regulated pressure range	Voltage (V)	Current (mA)	Resistance ( $\Omega$ ) $\pm$ 5%	Hysteresis pA
CE000850	CECS-005-PRPN-95-371-N020-12DT	0-20 bar (0-290 psi)	12	1500	4.72	< 0.4 bar (< 5,8 psi)
CE000851	CECS-005-PRPN-95-371-N020-24DT	0-20 bar (0-290 psi)	24	750	20.8	< 0.4 bar (< 5,8 psi)
CE000852	CECS-005-PRPN-95-371-N025-12DT	0-25 bar (0-363 psi)	12	1500	4.72	< 0.5 bar (< 7,3 psi)
CE000853	CECS-005-PRPN-95-371-N025-24DT	0-25 bar (0-363 psi)	24	750	20.8	< 0.5 bar (< 7,3 psi)
CE000893	CECS-005-PRPN-95-371-N032-12DT	0-32 bar (0-464 psi)	12	1500	4.72	< 0.7 bar (< 10,2 psi)
CE000862	CECS-005-PRPN-95-371-N032-24DT	0-32 bar (0-464 psi)	24	750	20.8	< 0.7 bar (< 10,2 psi)

SOLENOID OPERATED CARTRIDGE

# CECT-080-PRPS

PROPORTIONAL VALVES  
PILOTED OPERATED PRESSURE  
REDUCING AND RELIEVING

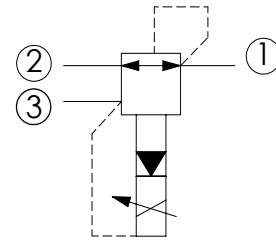
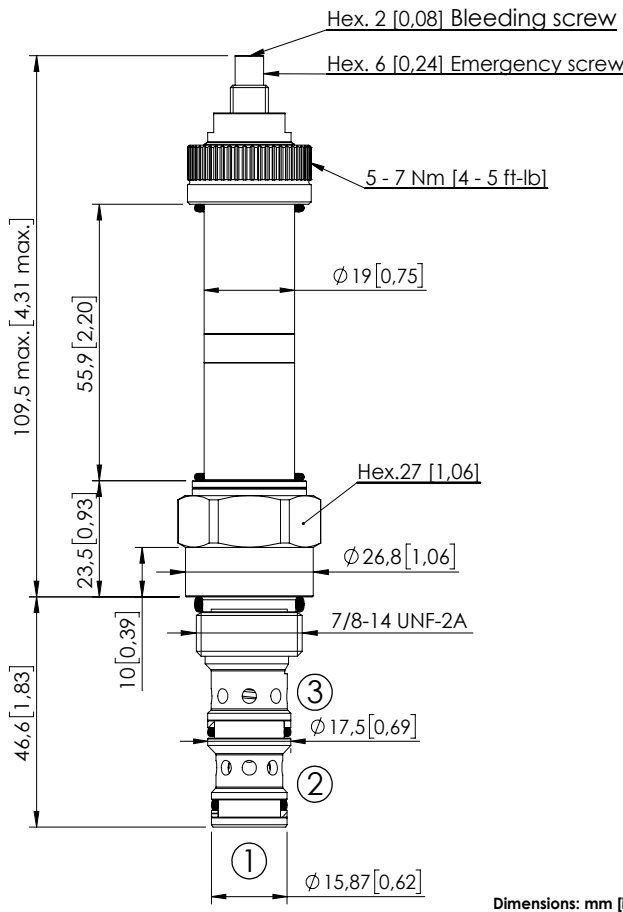

### SPECIFICATIONS

Max. operating pressure:	250 bar (3600 psi)
Rated flow:	80 l/min (32 gpm)
Cavity:	SAE-10-3N
Weight:	0,33 kg (0,46 lbs)
Type hydraulic fluid:	See Technical specif.
Hydraulic fluid temp. range:	-30/+100 °C (-22/+212 °F)
Contamination class to ISO 4406:	See technical spec.
Coil type:	M15 type
Ambient temperature:	-20/+50 °C (-4/+122 °F)
PWM range recommended:	120-150 Hz
Installation torque:	55 - 62 Nm (41 - 46 ft-lb)
Seal kit:	RA100092
MTF <sub>d</sub> :	150 - 1200 years: See technical spec.

### NOTES

Bleed air before use

For other configurations/quick codes not available in this catalogue page please consult factory

### CURVES

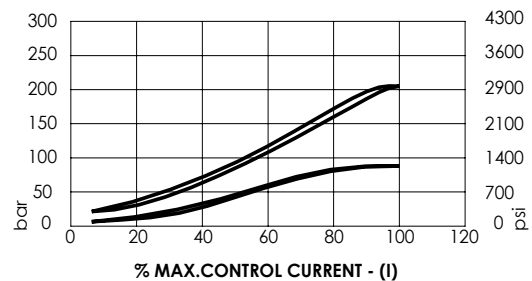
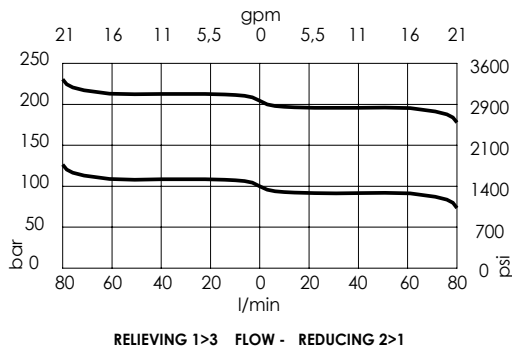

### ORDERING CODES

Quick code	Description	Regulated pressure range	Threshold current (with 12VDC coil)	Max control current (with 12V DC coil)	Override
CE000122	CECT-080-PRPS-96-S10-V210	20-220 bar (300-3100 psi)	200 mA (+/-7%)	1700 mA (+/-7%)	Screw style
CE000915	CECT-080-PRPS-96-S10-V080	4-80 bar (60-1200 psi)	200 mA (+/-7%)	1800 mA (+/-7%)	Screw style

SOLENOID OPERATED CARTRIDGE

# CEBD-005-PLPS

PROPORTIONAL VALVES  
POPPET TYPE RELIEF

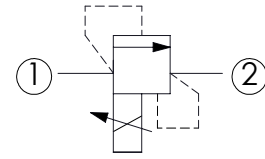
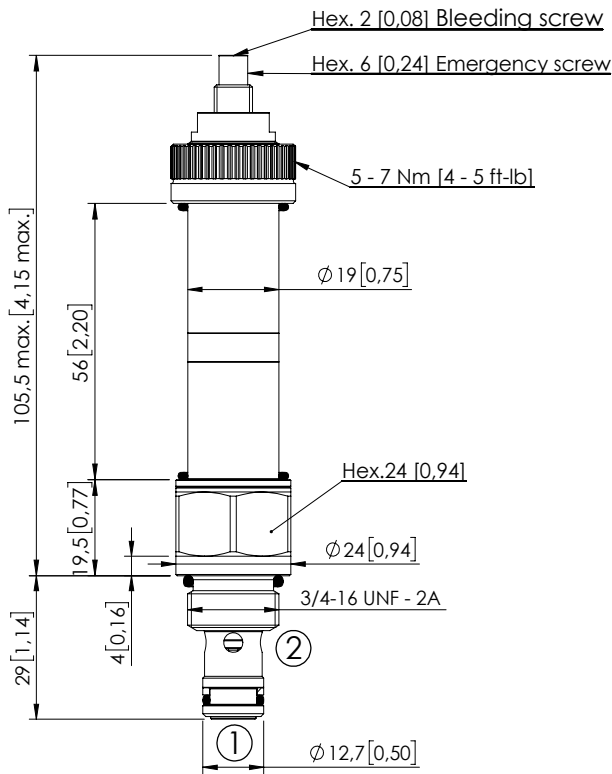

### SPECIFICATIONS

Max. operating pressure:	350 bar (5000 psi)
Rated flow:	3 l/min (0,8 gpm)
Cavity:	SAE-08-2N
Weight:	0,27 kg (0,35 lbs)
Type hydraulic fluid:	See Technical specif.
Hydraulic fluid temp. range:	-30/+100 °C (-22/+212 °F)
Contamination class to ISO 4406:	See technical spec.
Coil type:	M15 type
Ambient temperature:	-20/+50 °C (-4/+122 °F)
PWM range recommended:	150-180 Hz
Installation torque:	45 - 50 Nm (33 - 37 ft-lb)
Seal kit:	RA100081
MTTFd:	150 - 1200 years: See technical spec.

Dimensions: mm [inches]

### NOTES

Bleed air before use

For other configurations/quick codes not available in this catalogue page please consult factory

### CURVES

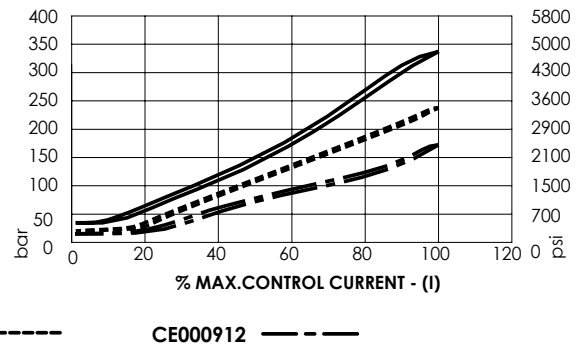
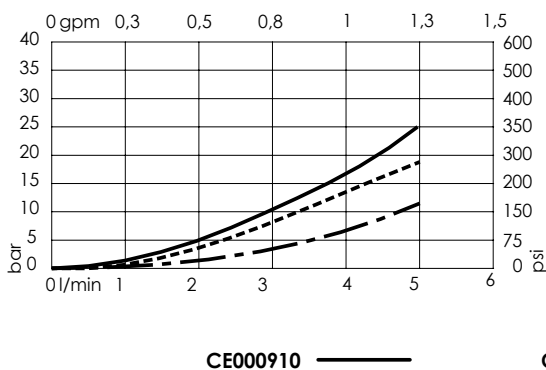

### ORDERING CODES

Quick code	Description	Setting range	Threshold current (with 12VDC coil)	Max control current (with 12V DC coil)	Override
CE000910	CEBD-005-PLPS-92-S08-V350	25-340 bar (350-4500 psi)	250 mA (+/-7%)	1800 mA (+/-7%)	Screw style
CE000911	CEBD-005-PLPS-92-S08-V200	17-250 bar (250-3600 psi)	200 mA (+/-7%)	1800 mA (+/-7%)	Screw style
CE000912	CEBD-005-PLPS-92-S08-V100	9-160 bar (130-2300 psi)	200 mA (+/-7%)	1800 mA (+/-7%)	Screw style

Revision B3

SOLENOID OPERATED CARTRIDGE

# CEBD-001-PMPS

PROPORTIONAL VALVES  
POPPET TYPE RELIEF  
SPOOL TYPE  
FOR INVERSE CONTROLLED

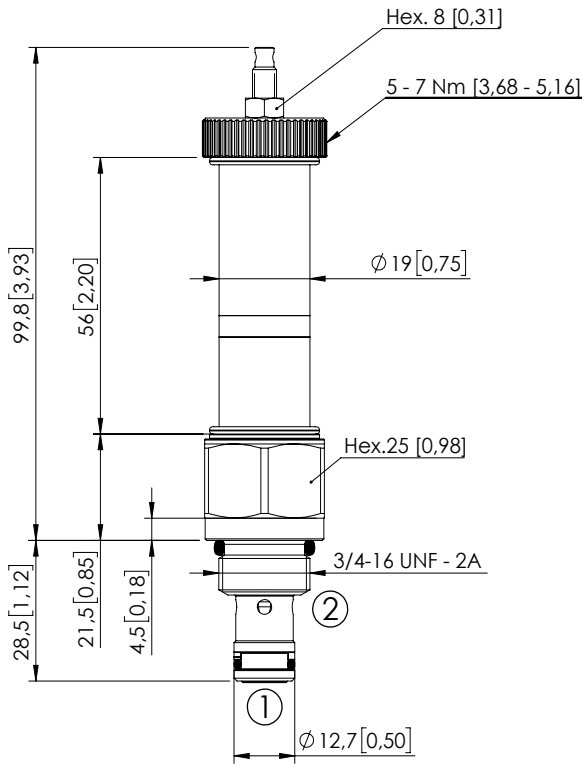

Dimensions: mm [inches]

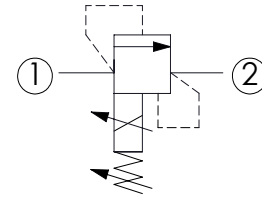

## SPECIFICATIONS

Max. operating pressure:	320 bar (4600 psi)
Rated flow:	0,6 l/min (0,15 gpm)
Cavity:	SAE-08-2N
Weight:	0,12 kg (0,44 lbs)
Type hydraulic fluid:	See Technical specif.
Hydraulic fluid temp. range:	-30/+100 °C (-22/+212 °F)
Contamination class to ISO 4406:	See technical spec.
Coil type:	M15 type
Ambient temperature:	-20/+50 °C (-4/+122 °F)
PWM range recommended:	150-180 Hz
Installation torque:	45 - 50 Nm (33,2 - 36,9 ft-lb)
Seal kit:	RA100081
MTF <sub>a</sub> :	150 - 1200 years: See technical spec.

## NOTES

Pressure decreasing with current increasing.  
Maximum pressure value can be adjusted manually within a range.  
For other configurations/quick codes not available in this catalogue page please consult factory

## CURVES

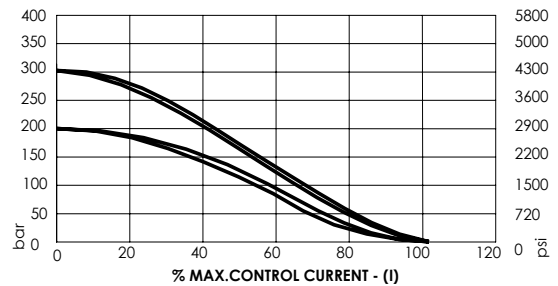
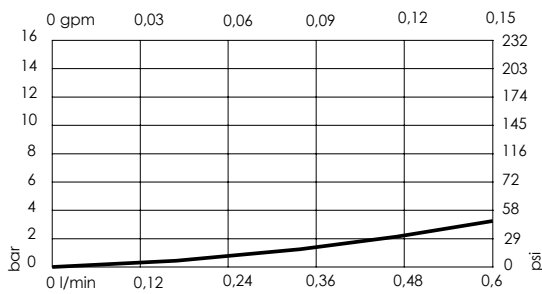

## ORDERING CODES

Quick code	Description	Max. pressure setting range	Standard setting	Threshold current (with 12VDC coil)	Max control current (with 12V DC coil)	Override
CE001120	CEBD-001-PMPS-92-S08-V320	200-320 bar (2900-4600 psi)	210 bar (3000 psi)	200 mA (+/-7%)	1600 mA (+/-7%)	Screw style

SOLENOID OPERATED CARTRIDGE

# CEBT-120-PMPS

PROPORTIONAL VALVES  
POPPET TYPE RELIEF  
SPOOL TYPE  
FOR INVERSE CONTROLLED

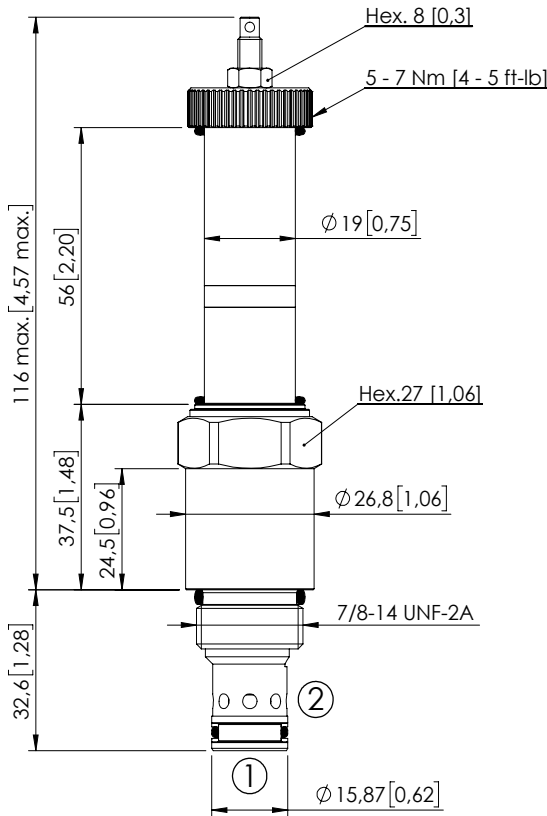

Dimensions: mm [inches]

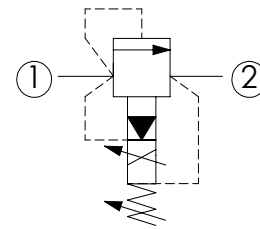

## SPECIFICATIONS

Max. operating pressure (port 1):	320 bar (4600 psi)
Max. operating pressure (port 2):	250 bar (3600 psi)
Rated flow:	120 l/min (32 gpm)
Pilot oil:	< 0,8 l/min (<0,2 gpm)
Type hydraulic fluid:	See Technical specif.
Hydraulic fluid temp. range:	-30/+100 °C (-22/+212 °F)
Viscosity range:	10 to 380 mm <sup>2</sup> /s
Contamination class to ISO 4406:	See technical spec.
Max. int. leakage:	200 cm <sup>3</sup> /min (@46 cSt, Δp=250 bar) 0,05 in <sup>3</sup> /min (@46 cSt, Δp=3600 psi)
Step response:	80 ms (Depending on the system)
Cavity:	SAE-10-2N
Weight:	0,21 kg (0,46 lbs)
Coil type:	M15 type
Ambient temperature:	-20/+50 °C (-4/+122 °F)
Hysteresis:	< 4% of the max. set pressure
PWM range recommended:	150-180 Hz
Installation torque:	55 - 62 Nm (41 - 46 ft-lb)
Seal kit:	RB100082
MTF <sub>d</sub> :	150 - 1200 years: See technical spec.

## NOTES

Pressure decreasing with current increasing.  
Maximum pressure value can be adjusted manually within a range.  
For other configurations/quick codes not available in this catalogue page please consult factory

## CURVES

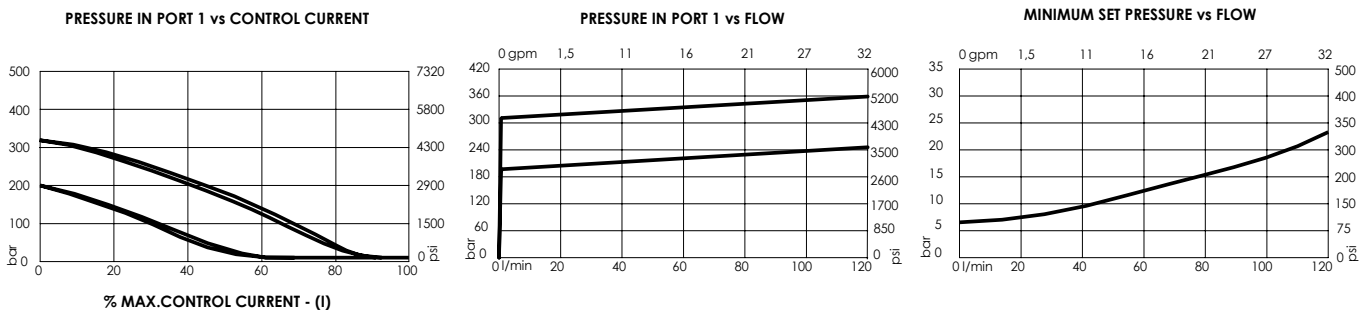

## ORDERING CODES

Quick code	Description	Minimum pressure	Max. pressure setting range	Standard setting	Threshold current (with 12VDC coil)	Max control current (with 12V DC coil)
CE000890	CEBT-120-PMPS-91-S10-V320	7 bar (100 psi)	200-320 bar (2900-4600 psi)	210 bar (3000 psi)	200 mA (+/-7%)	1600 mA (+/-7%)

SOLENOID OPERATED CARTRIDGE

# CEBT-120-PLPS

PROPORTIONAL VALVES  
PILOTED RELIEF  
SPOOL TYPE

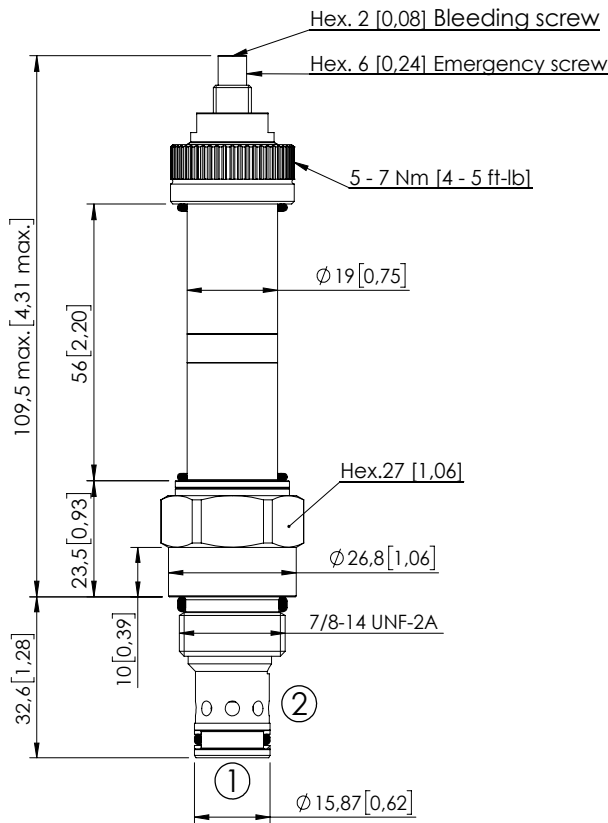

Dimensions: mm [inches]

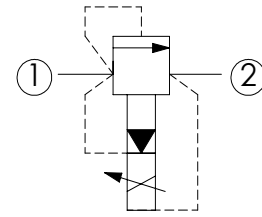

## SPECIFICATIONS

Max. operating pressure:	350 bar (5000 psi)
Rated flow:	120 l/min (32 gpm)
Cavity:	SAE-10-2N
Weight:	0,31 kg (0,44 lbs)
Type hydraulic fluid:	See Technical specif.
Hydraulic fluid temp. range:	-30/+100 °C (-22/+212 °F)
Contamination class to ISO 4406:	See technical spec.
Coil type:	M15 type
Ambient temperature:	-20/+50 °C (-4/+122 °F)
PWM range recommended:	150-180 Hz
Installation torque:	55 - 62 Nm (41 - 46 ft-lb)
Max. int. leakage:	200 cm <sup>3</sup> /min (@46 cSt) 12 in <sup>3</sup> /min (@46 cSt)
Seal kit:	RB100082
MTF <sub>d</sub> :	150 - 1200 years: See technical spec.

## NOTES

Bleed air before use  
For other configurations/quick codes not available in this catalogue page please consult factory

## CURVES

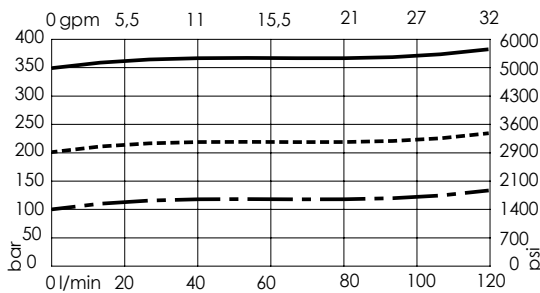

CE000119 1>2 ———

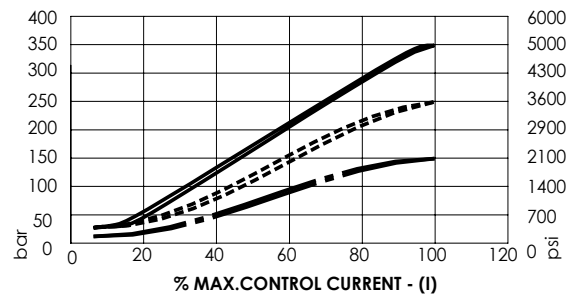

CE000120 1>2 - - - - -

CE000121 1>2 - . - . - .

## ORDERING CODES

Quick code	Description	Setting range	Threshold current (with 12VDC coil)	Max control current (with 12V DC coil)	Override
CE000119	CEBT-120-PLPS-91-S10-V350	30-350 bar (450-5000 psi)	200 mA (+/-7%)	1600 mA (+/-7%)	Screw style
CE000120	CEBT-120-PLPS-91-S10-V200	20-220 bar (300-3100 psi)	200 mA (+/-7%)	1700 mA (+/-7%)	Screw style
CE000121	CEBT-120-PLPS-91-S10-V100	15-90 bar (200-1300 psi)	200 mA (+/-7%)	1700 mA (+/-7%)	Screw style



SOLENOID OPERATED CARTRIDGE

# CEBT-300-PLPS

PROPORTIONAL VALVES  
PILOTED RELIEF  
SPOOL TYPE

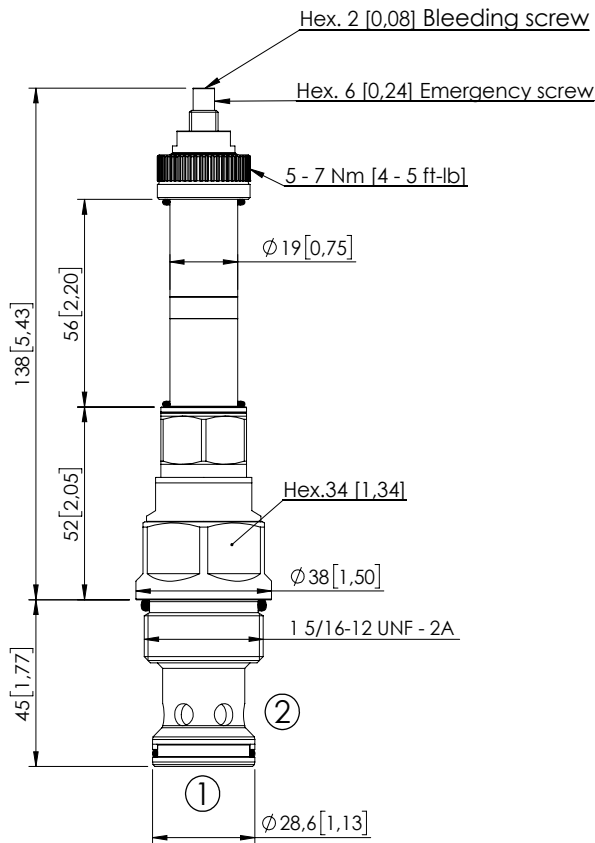

Dimensions: mm [inches]

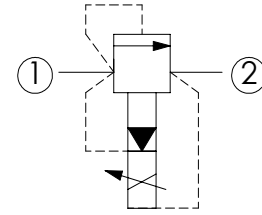

### SPECIFICATIONS

Max. operating pressure:	350 bar (5000 psi)
Rated flow:	300 l/min (80 gpm)
Cavity:	SAE-16-2N
Weight:	0,6 kg (1,10 lbs)
Type hydraulic fluid:	See Technical specif.
Hydraulic fluid temp. range:	-30/+100 °C (-22/+212 °F)
Contamination class to ISO 4406:	See technical spec.
Coil type:	M15 type
Ambient temperature:	-20/+50 °C (-4/+122 °F)
PWM range recommended:	150-180 Hz
Installation torque:	118 - 132 Nm (87 - 97 ft-lb)
Max. int. leakage:	200 cm <sup>3</sup> /min (@46 cSt) 12 in <sup>3</sup> /min (@46 cSt)
Seal kit:	RA100084
MTF <sub>d</sub> :	150 - 1200 years: See technical spec.

### NOTES

Bleed air before use

For other configurations/quick codes not available in this catalogue page please consult factory

### CURVES

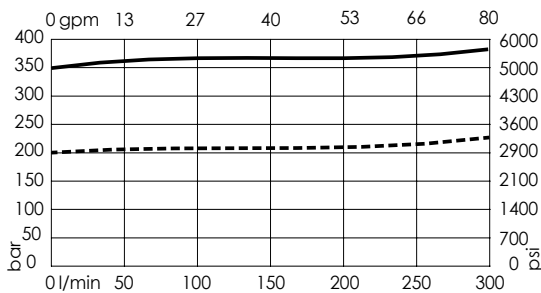

CE000880 1>2———

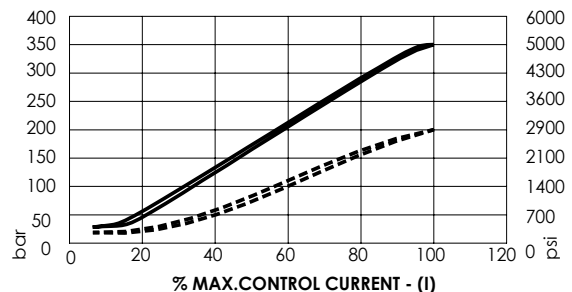

CE000895 1>2-----

### ORDERING CODES

Quick code	Description	Proportional setting range	Threshold current (with 12VDC coil)	Max control current (with 12V DC coil)	Override
CE000880	CEBT-300-PLPS-91-S16-V350	30-350 bar (450-5000 psi)	200 mA (+/-7%)	1600 mA (+/-7%)	Screw style
CE000895	CEBT-300-PLPS-91-S16-V200	20-200 bar (300-2900 psi)	200 mA (+/-7%)	1700 mA (+/-7%)	Screw style

SOLENOID OPERATED CARTRIDGE

# CEBT-500-PLPS

PROPORTIONAL VALVES  
PILOTED RELIEF  
SPOOL TYPE

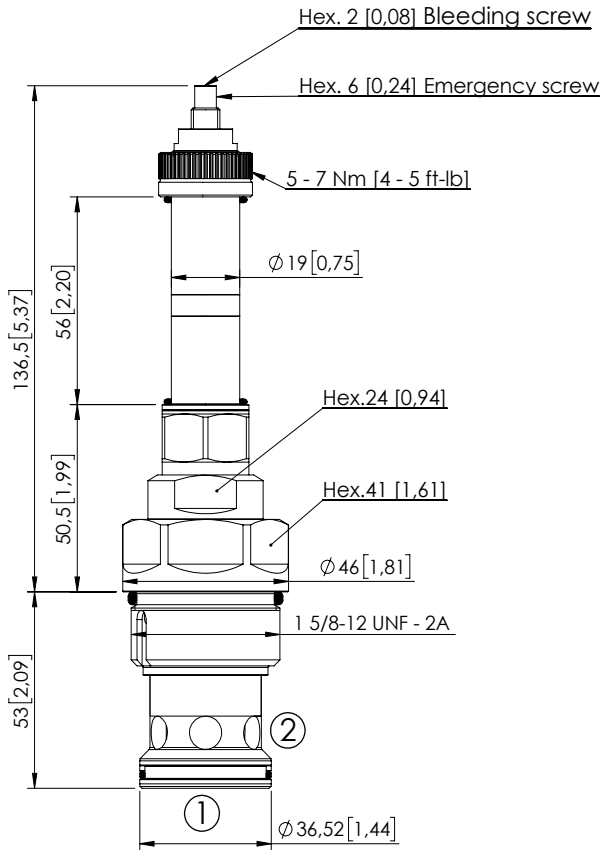

Dimensions: mm [inches]

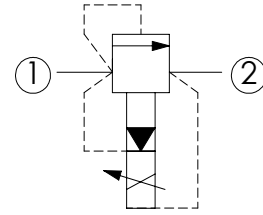

## SPECIFICATIONS

Max. operating pressure:	350 bar (5000 psi)
Rated flow:	500 l/min (132 gpm)
Cavity:	SAE-20-2N
Weight:	0,8 kg (1,76 lbs)
Type hydraulic fluid:	See Technical specif.
Hydraulic fluid temp. range:	-30/+100 °C (-22/+212 °F)
Contamination class to ISO 4406:	See technical spec.
Coil type:	M15 type
Ambient temperature:	-20/+50 °C (-4/+122 °F)
PWM range recommended:	150-180 Hz
Installation torque:	230 - 250 Nm (170 - 184 ft-lb)
Max. int. leakage:	200 cm <sup>3</sup> /min (@46 cSt) 12 in <sup>3</sup> /min (@46 cSt)
Seal kit:	RA100085
MTF <sub>a</sub> :	150 - 1200 years: See technical spec.

## NOTES

Bleed air before use

For other configurations/quick codes not available in this catalogue page please consult factory

## CURVES

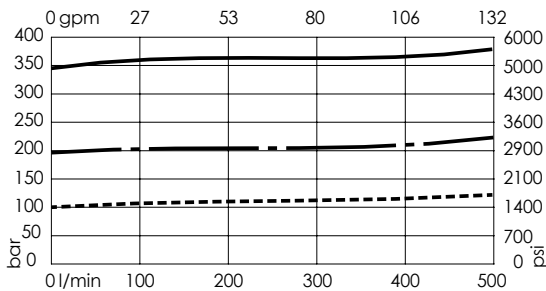

CE000770 1>2———

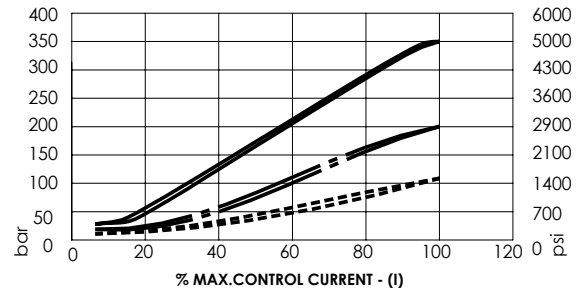

CE000772 1>2-----

CE000771 1>2----

## ORDERING CODES

Quick code	Description	Proportional setting range	Threshold current (with 12VDC coil)	Max control current (with 12V DC coil)	Override
CE000770	CEBT-500-PLPS-91-S20-V350	30-350 bar (450-5000 psi)	200 mA (+/-7%)	1600 mA (+/-7%)	Screw style
CE000771	CEBT-500-PLPS-91-S20-V200	20-220 bar (300-3100 psi)	200 mA (+/-7%)	1700 mA (+/-7%)	Screw style
CE000772	CEBT-500-PLPS-91-S20-V100	15-90 bar (200-1300 psi)	200 mA (+/-7%)	1700 mA (+/-7%)	Screw style

SOLENOID OPERATED CARTRIDGE

# CECS-040-FSPS

PROPORTIONAL VALVES  
NON COMPENSATED  
FLOW REGULATOR

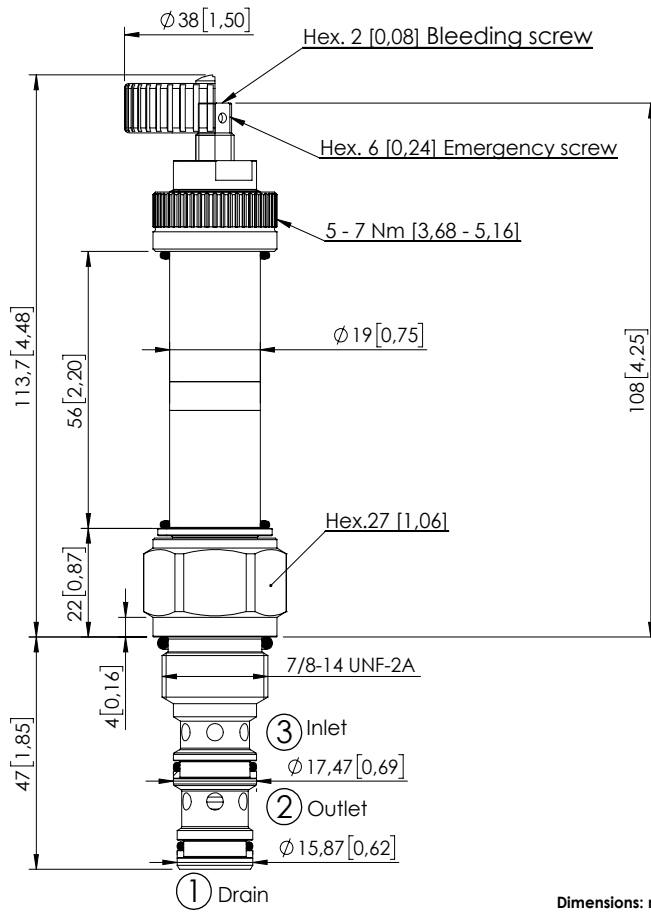

Dimensions: mm [inches]

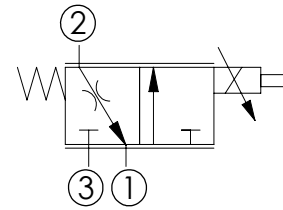

### SPECIFICATIONS

Max. operating pressure:	210 bar (3000 psi)
Rated flow:	40 l/min (11 gpm)
Cavity:	SAE-10-3N
Weight:	0,22 kg (0,49 lbs)
Type hydraulic fluid:	See Technical specif.
Hydraulic fluid temp. range:	-30/+100 °C (-22/+212 °F)
Contamination class to ISO 4406:	See technical spec.
Coil type:	M15 type
Ambient temperature:	-20/+50 °C (-4/+122 °F)
PWM range recommended:	150-180 Hz
Installation torque:	55 - 62 Nm (41 - 46 ft-lb)
Max. int. leakage:	150 cm <sup>3</sup> /min (@46 cSt) 9 in <sup>3</sup> /min (@46 cSt)
Seal kit:	RA100092
MTF <sub>d</sub> :	150 - 1200 years: See technical spec.

### NOTES

Bleed air before use  
For other configurations/quick codes not available in this catalogue page please consult factory

### CURVES

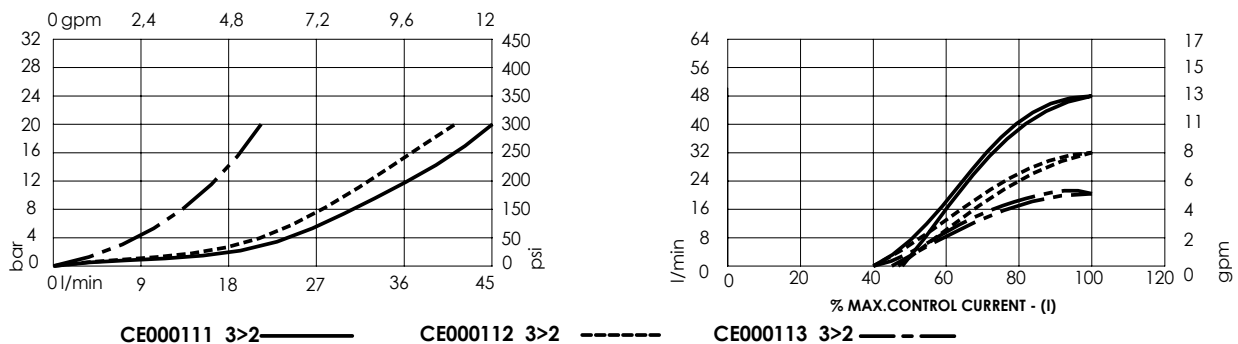

### ORDERING CODES

Quick code	Description	Rated flow	Threshold current (with 12VDC coil)	Max control current (with 12V DC coil)	Override
CE000111	CECS-040-FSPS-85-S10-V210	40 l/min (11 gpm)	800 mA (+/-7%)	1600 mA (+/-7%)	Screw style
CE000112	CECS-030-FSPS-85-S10-V210	30 l/min (8 gpm)	700 mA (+/-7%)	1500 mA (+/-7%)	Screw style
CE000113	CECS-020-FSPS-85-S10-V210	20 l/min (6 gpm)	700 mA (+/-7%)	1400 mA (+/-7%)	Screw style
CE000960	CECS-040-FSPV-85-S10-V210	40 l/min (11 gpm)	800 mA (+/-7%)	1600 mA (+/-7%)	Handknob style
CE000906	CECS-030-FSPV-85-S10-V210	30 l/min (8 gpm)	700 mA (+/-7%)	1500 mA (+/-7%)	Handknob style
CE000489	CECS-020-FSPV-85-S10-V210	20 l/min (6 gpm)	700 mA (+/-7%)	1400 mA (+/-7%)	Handknob style

SOLENOID OPERATED CARTRIDGE

# CECS-050-FRPN

PROPORTIONAL VALVES  
FLOW REGULATOR  
3 WAYS COMBINATION

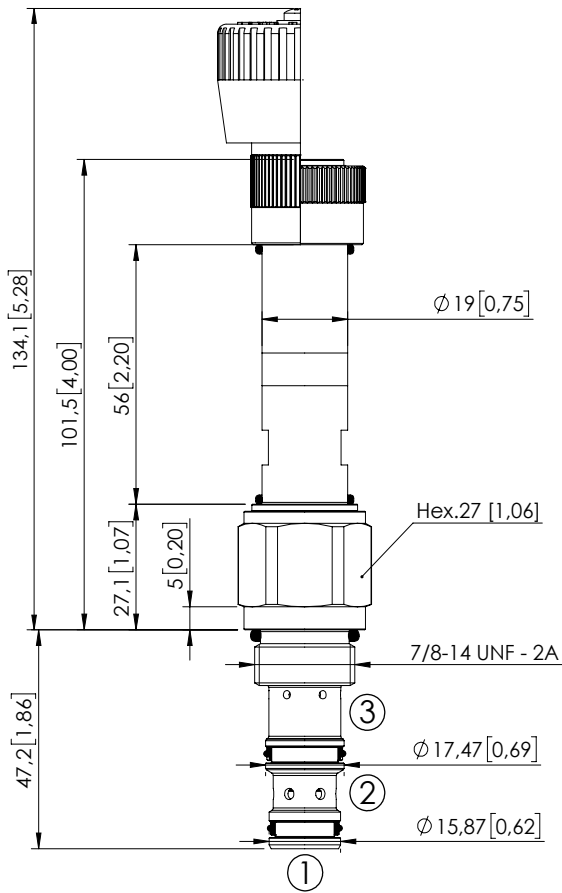

Dimensions: mm [inches]

3 way application

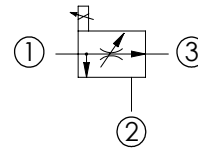

2 way application, port 2 not connected

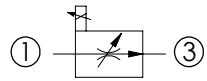

### SPECIFICATIONS

Max. operating pressure:	320 bar (4600 psi)
Max. flow (in inlet port ①):	50 l/min (13 gpm)
Max. flow ① to ③:	35 l/min REGULATED (9 gpm)
Cavity:	SAE-10-3N
Weight:	0,250 kg (0,55 lbs)
Type hydraulic fluid:	See Technical specif.
Hydraulic fluid temp. range:	-30/+100 °C (-22/+212 °F)
Contamination class to ISO 4406:	See technical spec.
Coil type:	M15 type
Voltage:	12- 24 V dc
Ambient temperature:	-20/+50 °C (-4/+122 °F)
PWM range recommended:	180 Hz
Pressure differential (① to ③):	7-11 bar (101 - 159 psi)
Hysteresis (ramp up and down):	5 %
Max current (12 V dc):	1800 mA
Max current (24 V dc):	900 mA
Coil resistance (12 V dc):	5,8-6,7 Ω
Coil resistance (24 V dc):	23,3-26,8 Ω
Surface protection proportional solenoid:	Coating DIN 50962 Fe8/ Zi-Ni with passivation
Installation torque:	55 - 62 Nm (41 - 46 ft-lb)
Seal kit:	RB100092
MTF <sub>a</sub> :	150 - 1200 years: See technical spec.

### NOTES

For other configurations/quick codes not available in this catalogue page please consult factory

### CURVES

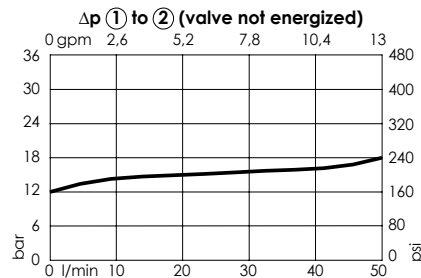
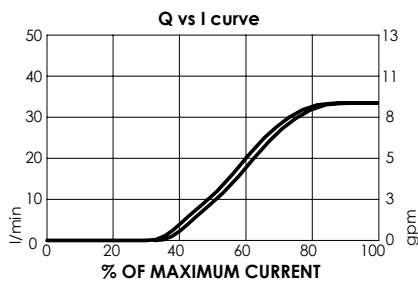

### ORDERING CODES

Quick code	Description	Regulated flow range	Adjustment type
CE001144	CECS-050-FRPN-35-S10-V320	0-35 l/min (0-9 gpm)	Standard
CE001882	CECS-050-FRPN-35-S10-V320	0-35 l/min (0-9 gpm)	Handknob

SOLENOID OPERATED CARTRIDGE

# CECS-140-FRPM

PROPORTIONAL VALVES  
FLOW REGULATOR  
PRIORITY TYPE

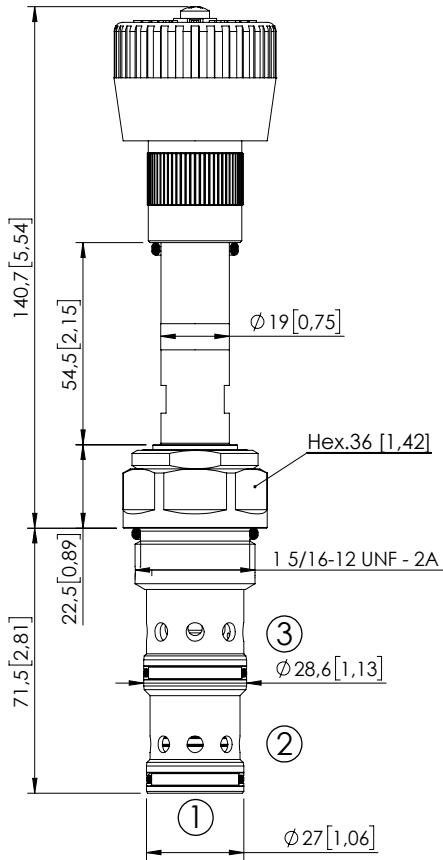

Dimensions: mm [inches]

3 way application

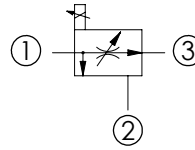

2 way application, port 2 not connected

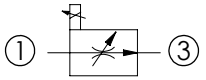

**SPECIFICATIONS**

Max. operating pressure:	320 bar (4600 psi)
Max. flow (in inlet port ①):	140 l/min (37 gpm)
Max. flow ① to ③:	120 l/min REGULATED (32 gpm)
Cavity:	SAE-16-3N
Weight:	0,6 kg (1,32 lbs)
Type hydraulic fluid:	See Technical specif.
Hydraulic fluid temp. range:	-30/+100 °C (-22/+212 °F)
Contamination class to ISO 4406:	See technical spec.
Coil type:	M15 type
Voltage:	12- 24 V dc
Ambient temperature:	-20/+50 °C (-4/+122 °F)
PWM range recommended:	180 Hz
Pressure differential (① to ③):	7-11 bar (101 - 159 psi)
Hysteresis (ramp up and down):	1,5 - 3 %
Max current (12 V dc):	1800 mA
Max current (24 V dc):	900 mA
Coil resistance (12 V dc):	5,8-6,7 Ω
Coil resistance (24 V dc):	23,3-26,8 Ω
Surface protection proportional solenoid:	Coating DIN 50962 Fe8/ Zi-Ni with passivation
Installation torque:	118 - 132 Nm (160 - 179 ft-lb)
Seal kit:	RB100094
MTF <sub>a</sub> :	150 - 1200 years: See technical spec.

**NOTES**

If port 2 is blocked the valve operates as a two way flow regulator. Port 2 can be pressurized. For other configurations/quick codes not available in this catalogue page please consult factory

**CURVES**

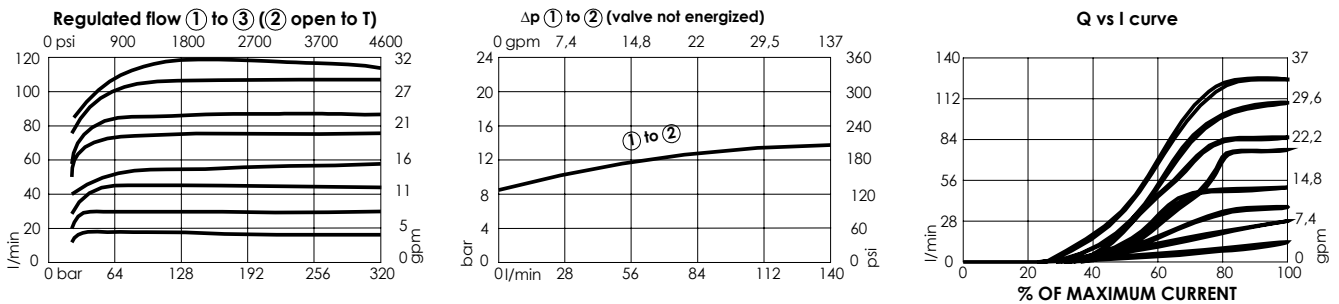

**ORDERING CODES**

Quick code	Description	Regulated flow range	Adjustment type
CE000831	CECS-140-FRPM-15-S16-V320	0-15 l/min (0-4 gpm)	Handknob
CE000832	CECS-140-FRPM-25-S16-V320	0-25 l/min (0-7 gpm)	Handknob
CE000833	CECS-140-FRPM-40-S16-V320	0-40 l/min (0-11 gpm)	Handknob
CE000834	CECS-140-FRPM-50-S16-V320	0-50 l/min (0-13 gpm)	Handknob
CE000835	CECS-140-FRPM-65-S16-V320	0-65 l/min (0-17 gpm)	Handknob
CE000836	CECS-140-FRPM-80-S16-V320	0-80 l/min (0-21 gpm)	Handknob
CE001034	CECS-140-FRPM-100-S16-V320	0-100 l/min (0-27 gpm)	Handknob
CE001184	CECS-140-FRPM-120-S16-V320	0-120 l/min (0-32 gpm)	Handknob

SOLENOID OPERATED CARTRIDGE

# CEBD-020-PEPS

PROPORTIONAL VALVE  
NORMALLY CLOSED

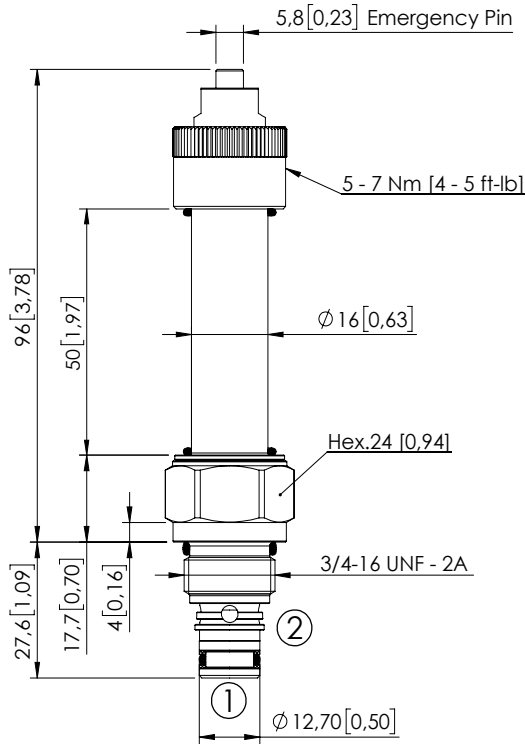

Dimensions: mm [inches]

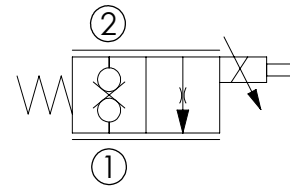

### SPECIFICATIONS

Max. operating pressure:	210 bar (3000 psi)
Rated flow:	20 l/min (5 gpm)
Cavity:	SAE 08-2N
Weight:	0,21 kg (0,33 lbs)
Type hydraulic fluid:	See Technical spec.
Hydraulic fluid temp. range:	-30/+100 °C (-22/+212 °F)
Contamination class to ISO 4406:	See technical spec.
Coil type:	M16 type
Ambient temperature:	-20/+50 °C (-4/+122 °F)
PWM range recommended:	120-150 Hz
Installation torque:	45 - 50 Nm (33 - 37 ft-lb)
Seal kit:	RA100081
MTF <sub>a</sub> :	150 - 1200 years: See technical spec.

### NOTES

Bleed air before use

For other configurations/quick codes not available in this catalogue page please consult factory

### CURVES

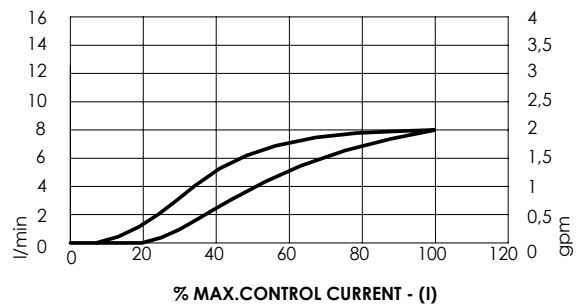
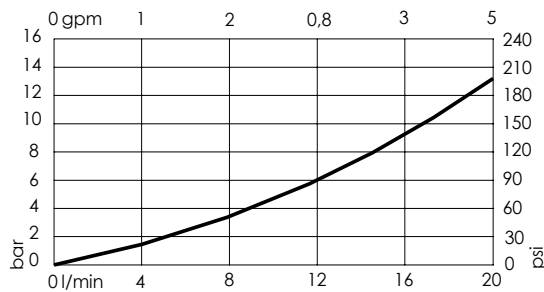

### ORDERING CODES

Quick code	Description	Rated flow	Threshold current (with 12VDC coil)	Max control current (with 12V DC coil)	Override
CE001190	CEBD-020-PEPS-103-S08-V210	20 l/min (5 gpm)	1000 mA (+/-7%)	2000 mA (+/-7%)	Push style

SOLENOID OPERATED CARTRIDGE

# CEBD-020-PEPS

PROPORTIONAL VALVE  
NORMALLY CLOSED

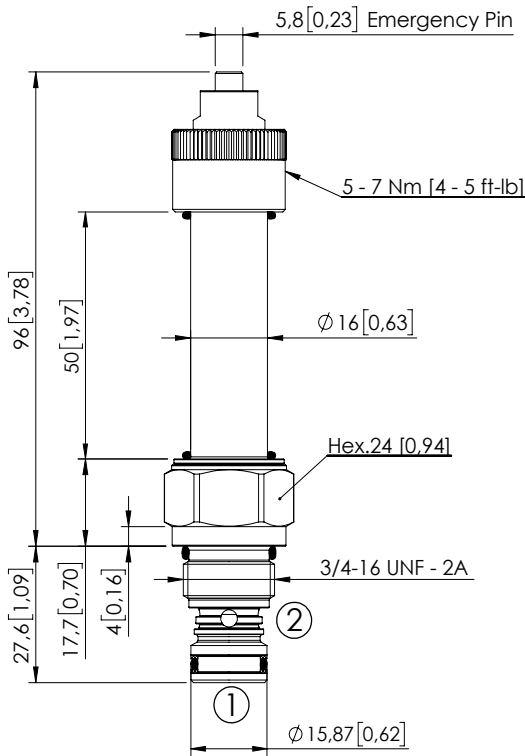

Dimensions: mm [inches]

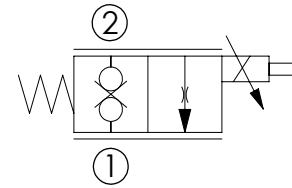

## SPECIFICATIONS

Max. operating pressure:	210 bar (3000 psi)
Rated flow:	20 l/min (5 gpm)
Cavity:	VP000064
Weight:	0,21 kg (0,33 lbs)
Type hydraulic fluid:	See Technical specif.
Hydraulic fluid temp. range:	-30/+100 °C (-22/+212 °F)
Contamination class to ISO 4406:	See technical spec.
Coil type:	M16 type
Ambient temperature:	-20/+50 °C (-4/+122 °F)
PWM range recommended:	150-180 Hz
Installation torque:	45 - 50 Nm (33 - 37 ft-lb)
Seal kit:	RA100081
MTF <sub>a</sub> :	150 - 1200 years: See technical spec.

## NOTES

Bleed air before use  
For other configurations/quick codes not available in this catalogue page please consult factory

## CURVES

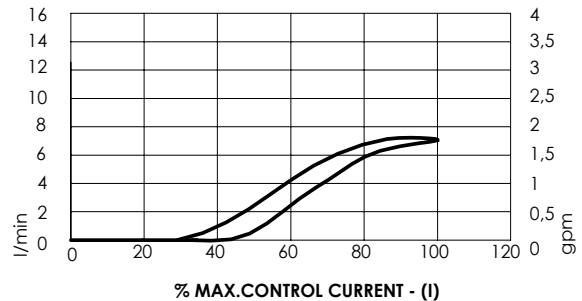
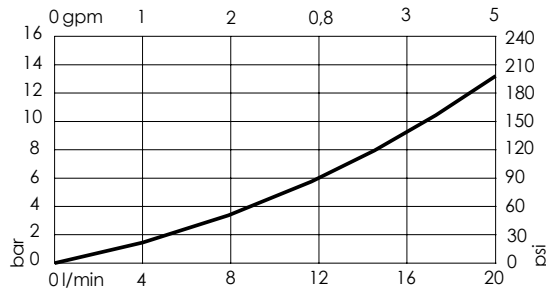

## ORDERING CODES

Quick code	Description	Rated flow	Threshold current (with 12VDC coil)	Max control current (with 12V DC coil)	Override
CE001116	CEBD-020-PEPS-103-064-V210	20 l/min (5 gpm)	1000 mA (+/-7%)	2000 mA (+/-7%)	Push style

SOLENOID OPERATED CARTRIDGE

# CEES-010-SEPN-51

DIRECT OPERATED  
SPOOL TYPE

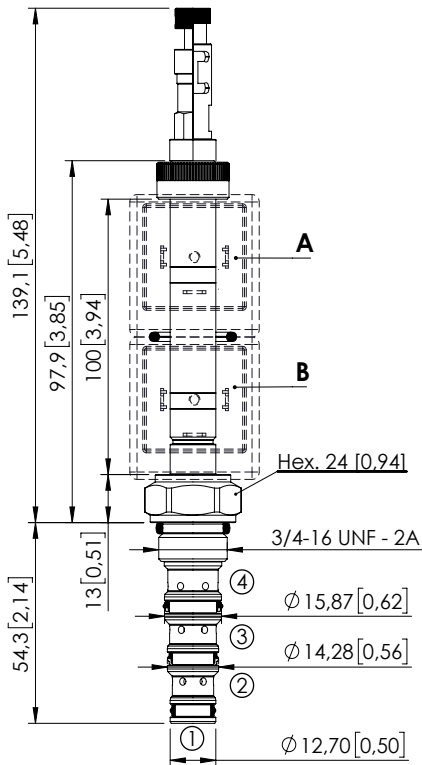

Dimensions: mm [inches]

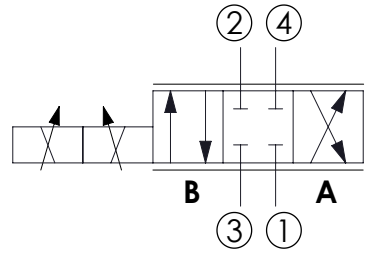

## SPECIFICATIONS

Max. operating pressure:	350 bar (5000 psi)
Max. operating pressure on port 1:	210 bar (3000 psi)
Rated flow:	10 l/min (3 gpm)
Cavity:	SAE-08-4N
Weight:	0.13 kg (0.68 lbs)
Min. voltage required:	90% of nominal
Coil type:	M7 or M3 type
Ambient temperature:	-20/+50 °C (-4/+122 °F)
PWM range recommended:	100 Hz
Contamination class to ISO 4406:	See technical spec.
Seal kit:	RB600101
Installation torque:	45 - 50 Nm (41 - 46 ft-lb)
MTF <sub>d</sub> :	150 - 1200 years: See technical spec.
Leakage:	120 cm <sup>3</sup> /min (@46 cSt) 7,3 in <sup>3</sup> /min (@46 cSt)

## NOTES

For other configurations/quick codes not available in this catalogue page please consult factory

## OPTIONS

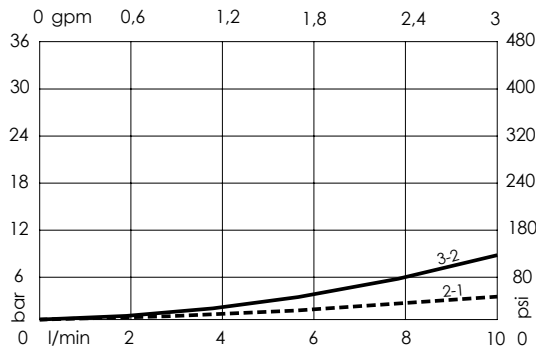

## ORDERING CODES

Quick code	Description	Options
CE001832	CEES-010-SEPN-51-S08-N350	Standard
CE001833	CEES-010-SEPL-51-S08-N350	Push and pull manual override
CE001834	CEES-010-SEPG-51-S08-N350	Push pull and twist manual override



SOLENOID OPERATED CARTRIDGE

# CEES-010-SEPN-52

DIRECT OPERATED  
SPOOL TYPE

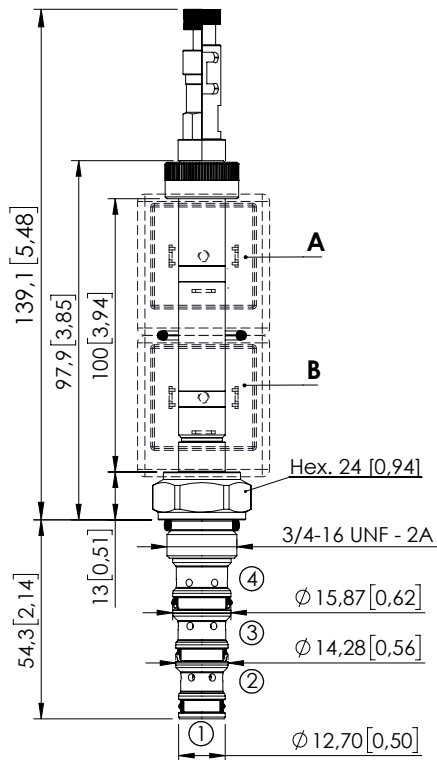

Dimensions: mm [inches]

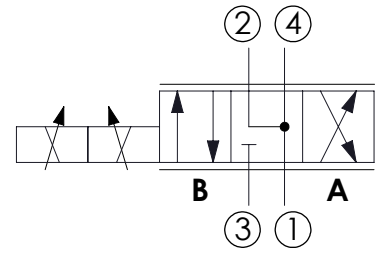

## SPECIFICATIONS

Max. operating pressure:	350 bar (5000 psi)
Max. operating pressure on port 1:	210 bar (3000 psi)
Rated flow:	10 l/min (3 gpm)
Cavity:	SAE-08-4N
Weight:	0.13 kg (0,68 lbs)
Min. voltage required:	90% of nominal
Coil type:	M7 or M3 type
Ambient temperature:	-20/+50 °C (-4/+122 °F)
PWM range recommended:	100 Hz
Contamination class to ISO 4406:	See technical spec.
Seal kit:	RB600101
Installation torque:	45 - 50 Nm (41 - 46 ft-lb)

## NOTES

For other configurations/quick codes not available in this catalogue page please consult factory

MTTF <sub>d</sub> :	150 - 1200 years: See technical spec.
Leakage:	120 cm <sup>3</sup> /min (@46 cSt) 7,3 in <sup>3</sup> /min (@46 cSt)

## OPTIONS

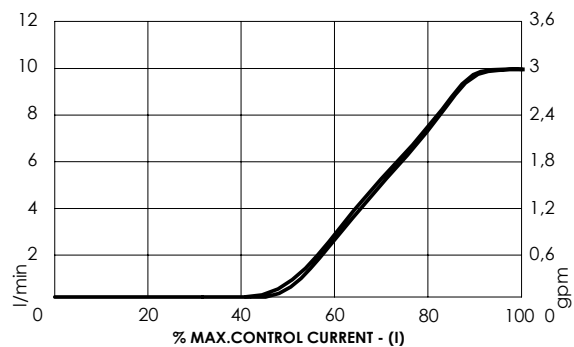
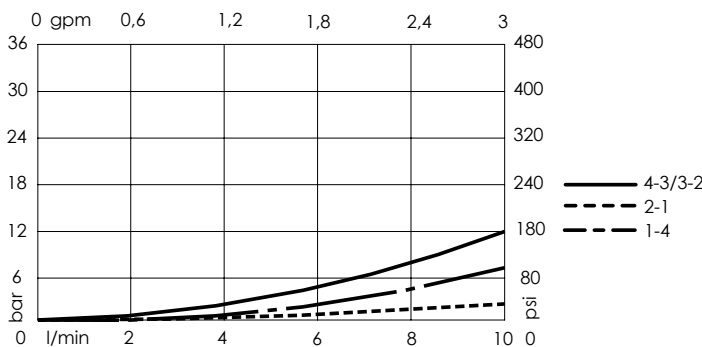
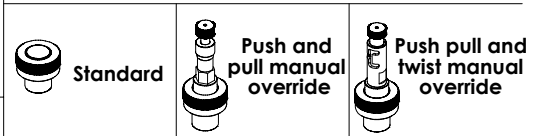

## ORDERING CODES

Quick code	Description	Options
CE001835	CEES-010-SEPN-52-S08-N350	Standard
CE001836	CEES-010-SEPL-52-S08-N350	Push and pull manual override
CE001837	CEES-010-SEPG-52-S08-N350	Push pull and twist manual override

SOLENOID OPERATED CARTRIDGE

# CEFS-010-SEPN-106

DIRECT OPERATED  
SPOOL TYPE

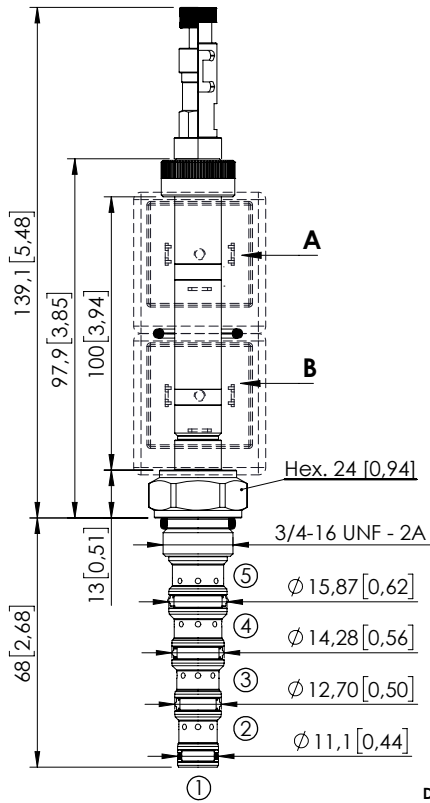

Dimensions: mm [inches]

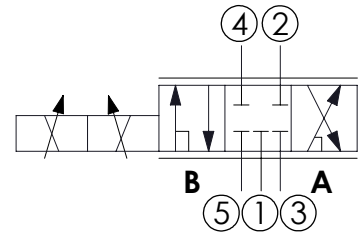

## SPECIFICATIONS

Max. operating pressure:	250 bar (3600 psi)
Max. operating pressure on port 1:	210 bar (3000 psi)
Rated flow:	10 l/min (3 gpm)
Cavity:	SAE-08-5N
Weight:	0.25 kg (0.68 lbs)
Min. voltage required:	90% of nominal
Coil type:	M7 or M3 type
Ambient temperature:	-20/+50 °C (-4/+122 °F)
PWM range recommended:	100 Hz
Contamination class to ISO 4406:	See technical spec.
Seal kit:	RB900106
Installation torque:	45 - 50 Nm (41 - 46 ft-lb)

## NOTES

For other configurations/quick codes not available in this catalogue page please consult factory

MTTFd:	150 - 1200 years: See technical spec.
Leakage:	120 cm <sup>3</sup> /min (@46 cSt) 7.3 in <sup>3</sup> /min (@46 cSt)

## OPTIONS

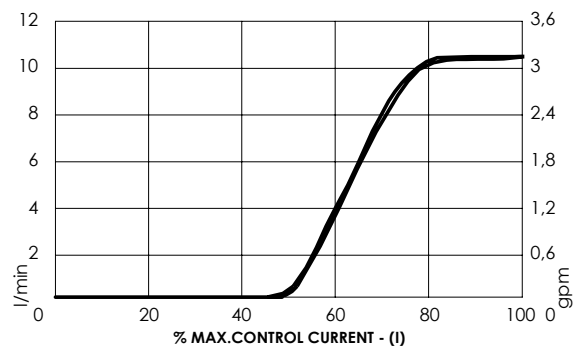
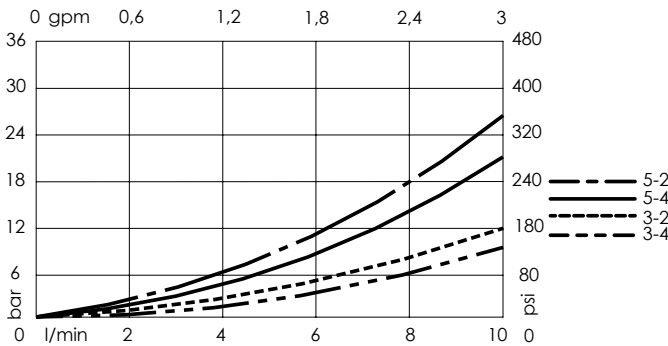

## ORDERING CODES

Quick code	Description	Options
CE001841	CEFS-010-SEPN-106-S08-N250	Standard
CE001842	CEFS-010-SEPL-106-S08-N250	Push and pull manual override
CE001843	CEFS-010-SEPG-106-S08-N250	Push pull and twist manual override

SOLENOID OPERATED CARTRIDGE

# CEFS-010-SEPN-107

DIRECT OPERATED  
SPOOL TYPE

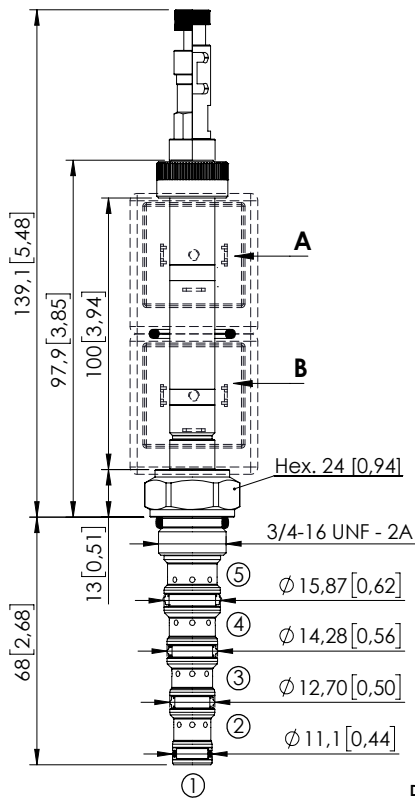

Dimensions: mm [inches]

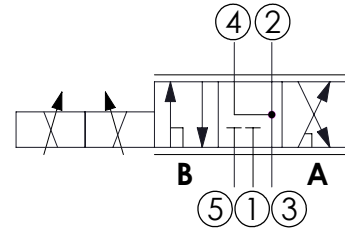

### SPECIFICATIONS

Max. operating pressure:	250 bar (3600 psi)
Max. operating pressure on port 1:	210 bar (3000 psi)
Rated flow:	10 l/min (3 gpm)
Cavity:	SAE-08-5N
Weight:	0.25 kg (0.68 lbs)
Min. voltage required:	90% of nominal
Coil type:	M7 or M3 type
Ambient temperature:	-20/+50 °C (-4/+122 °F)
PWM range recommended:	100 Hz
Contamination class to ISO 4406:	See technical spec.
Seal kit:	RB900106
Installation torque:	45 - 50 Nm (41 - 46 ft-lb)

### NOTES

For other configurations/quick codes not available in this catalogue page please consult factory

MTF <sub>a</sub> :	150 - 1200 years: See technical spec.
Leakage:	120 cm <sup>3</sup> /min (@46 cSt) 7.3 in <sup>3</sup> /min (@46 cSt)

### OPTIONS

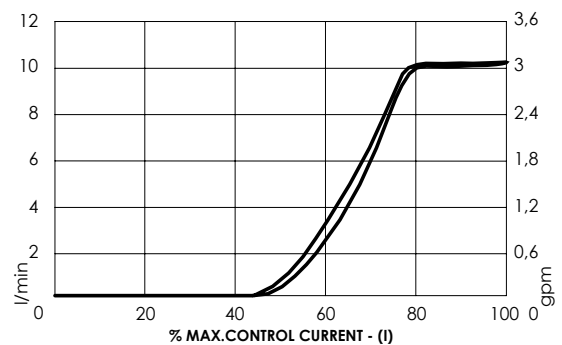
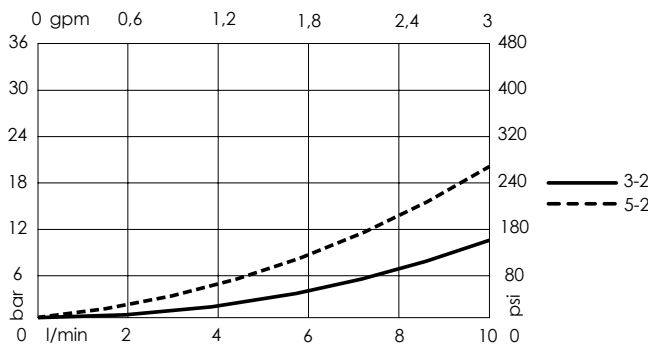

### ORDERING CODES

Quick code	Description	Options
CE001844	CEFS-010-SEPN-107-S08-N250	Standard
CE001845	CEFS-010-SEPL-107-S08-N250	Push and pull manual override
CE001846	CEFS-010-SEPG-107-S08-N250	Push pull and twist manual override

Revision B

SOLENOID OPERATED CARTRIDGE

# CEFS-010-SEPN-115

DIRECT OPERATED  
SPOOL TYPE

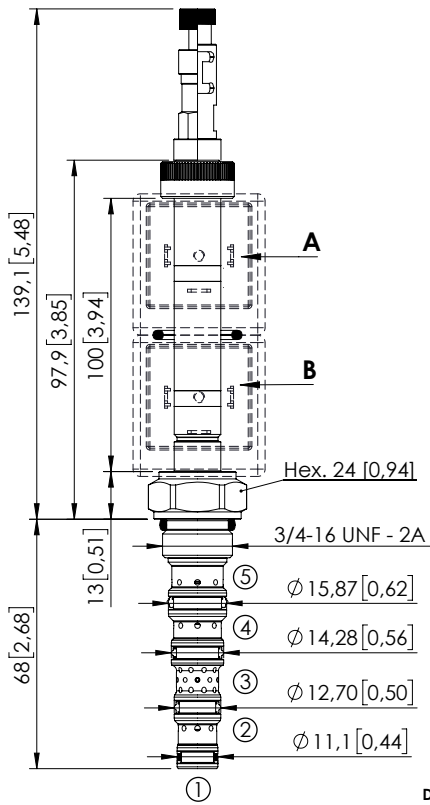

Dimensions: mm [inches]

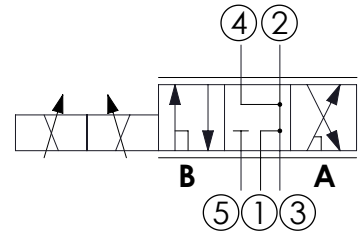

## SPECIFICATIONS

Max. operating pressure:	350 bar (5000 psi)
Max. operating pressure on port 1:	210 bar (3000 psi)
Rated flow:	10 l/min (3 gpm)
Cavity:	SAE-08-5N
Weight:	0,25 kg (0,68 lbs)
Min. voltage required:	90% of nominal
Coil type:	M7 or M3 type
Ambient temperature:	-20/+50 °C (-4/+122 °F)
PWM range recommended:	100 Hz
Contamination class to ISO 4406:	See technical spec.
Seal kit:	RB900106
Installation torque:	45 - 50 Nm (41 - 46 ft-lb)
MTTF <sub>a</sub> :	150 - 1200 years: See technical spec.
Leakage:	120 cm <sup>3</sup> /min (@46 cSI) 7,3 in <sup>3</sup> /min (@46 cSI)

## NOTES

For other configurations/quick codes not available in this catalogue page please consult factory

## OPTIONS

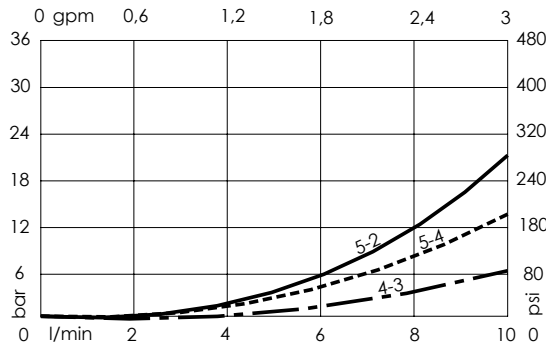

## ORDERING CODES

Quick code	Description	Options
CE001850	CEFS-010-SEPN-115-S08-N350	Standard
CE001851	CEFS-010-SEPL-115-S08-N350	Push and pull manual override
CE001852	CEFS-010-SEPG-115-S08-N350	Push pull and twist manual override

SOLENOID OPERATED CARTRIDGE

**CEES-030-SEPN-51**

DIRECT OPERATED  
SPOOL TYPE

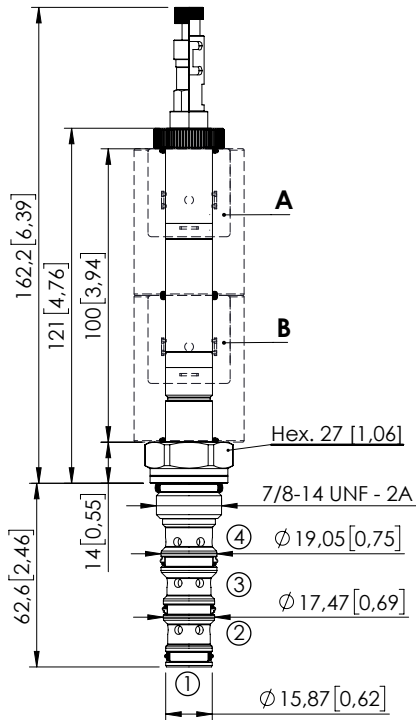

Dimensions: mm [inches]

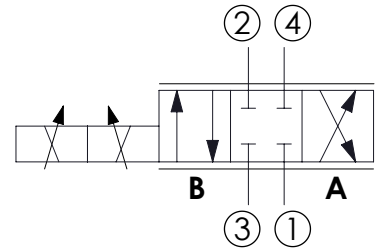

**SPECIFICATIONS**

Max. operating pressure:	350 bar (5000 psi)
Max. operating pressure on port 1:	210 bar (3000 psi)
Rated flow:	30 l/min (8 gpm)
Cavity:	SAE-10-4N
Weight:	0.20 kg (0,68 lbs)
Min. voltage required:	90% of nominal
Coil type:	M16
Ambient temperature:	-20/+50 °C (-4/+122 °F)
PWM range recommended:	100 Hz
Contamination class to ISO 4406:	See technical spec.
Seal kit:	RB600102
Installation torque:	55 - 62 Nm (41 - 46 ft-lb)
MTTF:	150 - 1200 years: See technical spec.
Leakage:	120 cm <sup>3</sup> /min (@46 cSt) 7,3 in <sup>3</sup> /min (@46 cSt)

**NOTES**

For other configurations/quick codes not available in this catalogue page please consult factory

**OPTIONS**

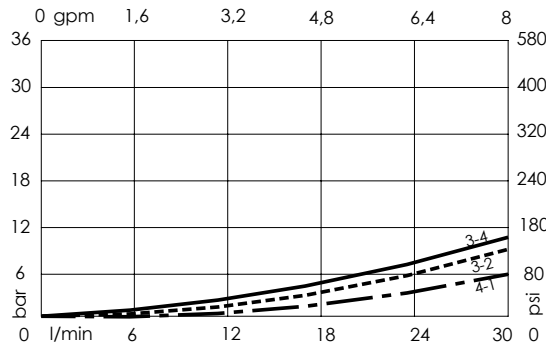

**ORDERING CODES**

Quick code	Description	Options
CE001853	CEES-030-SEPN-51-S10-N350	Standard
CE001854	CEES-030-SEPL-51-S10-N350	Push and pull manual override
CE001855	CEES-030-SEPG-51-S10-N350	Push pull and twist manual override

SOLENOID OPERATED CARTRIDGE

**CEES-030-SEPN-52**

DIRECT OPERATED  
SPOOL TYPE

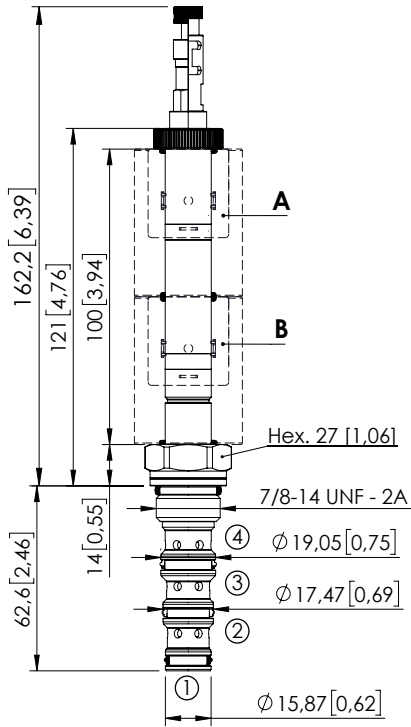

Dimensions: mm [inches]

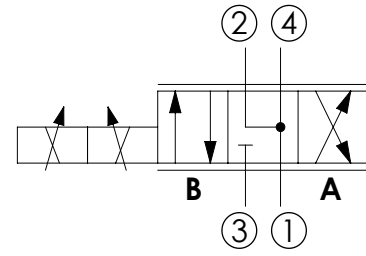

**SPECIFICATIONS**

Max. operating pressure:	350 bar (5000 psi)
Max. operating pressure on port 1:	210 bar (3000 psi)
Rated flow:	30 l/min (8 gpm)
Cavity:	SAE-10-4N
Weight:	0.20 kg (0.68 lbs)
Min. voltage required:	90% of nominal
Coil type:	M16
Ambient temperature:	-20/+50 °C (-4/+122 °F)
PWM range recommended:	100 Hz
Contamination class to ISO 4406:	See technical spec.
Seal kit:	RB600102
Installation torque:	55 - 62 Nm (41 - 46 ft-lb)
MTTF <sub>d</sub> :	150 - 1200 years: See technical spec.
Leakage:	120 cm <sup>3</sup> /min (@46 cSt) 7.3 in <sup>3</sup> /min (@46 cSt)

**NOTES**

For other configurations/quick codes not available in this catalogue page please consult factory

**OPTIONS**

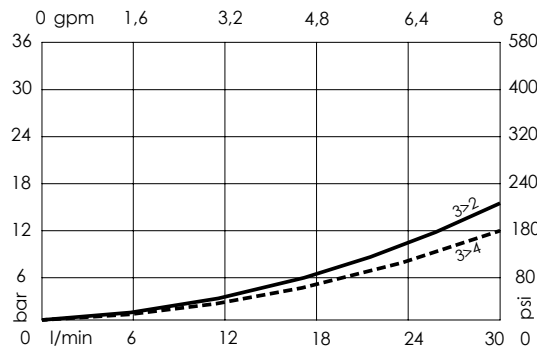

**ORDERING CODES**

Quick code	Description	Options
CE001856	CEES-030-SEPN-52-S10-N350	Standard
CE001857	CEES-030-SEPL-52-S10-N350	Push and pull manual override
CE001858	CEES-030-SEPG-52-S10-N350	Push pull and twist manual override

SOLENOID OPERATED CARTRIDGE

# CEFS-030-SEPN-106

DIRECT OPERATED  
SPOOL TYPE

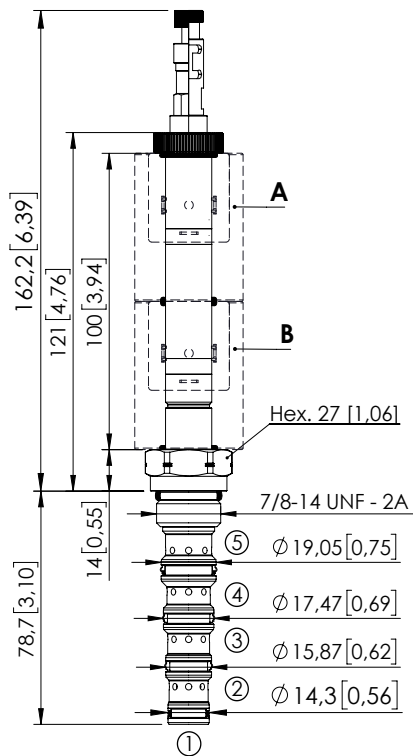

Dimensions: mm [inches]

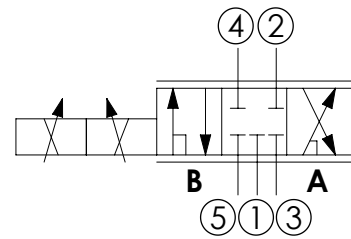

## SPECIFICATIONS

Max. operating pressure:	350 bar (5000 psi)
Max. operating pressure on port 1:	210 bar (3000 psi)
Rated flow:	30 l/min (8 gpm)
Cavity:	SAE 10 5N
Weight:	0.22 kg (0.68 lbs)
Min. voltage required:	90% of nominal
Coil type:	M16
Ambient temperature:	-20/+50 °C (-4/+122 °F)
PWM range recommended:	100 Hz
Contamination class to ISO 4406:	See technical spec.
Seal kit:	RB900107
Installation torque:	55 - 62 Nm (41 - 46 ft-lb)
MTF <sub>a</sub> :	150 - 1200 years: See technical spec.
Leakage:	120 cm <sup>3</sup> /min (@46 cSt) 7,3 in <sup>3</sup> /min (@46 cSt)

## NOTES

For other configurations/quick codes not available in this catalogue page please consult factory

## OPTIONS

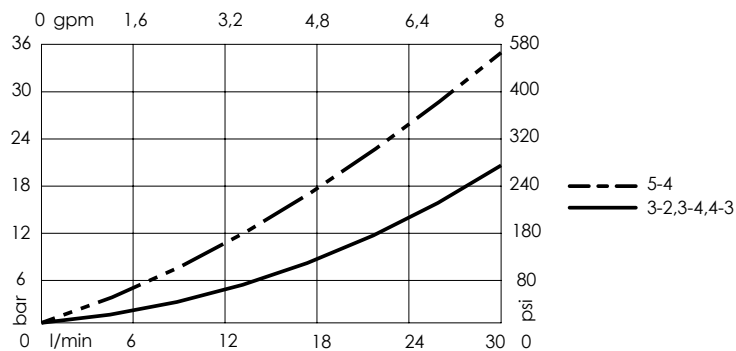

## ORDERING CODES

Quick code	Description	Options
CE001862	CEFS-030-SEPN-106-S10-N350	Standard
CE001863	CEFS-030-SEPL-106-S10-N350	Push and pull manual override
CE001864	CEFS-030-SEPG-106-S10-N350	Push pull and twist manual override

SOLENOID OPERATED CARTRIDGE

**CEFS-030-SEPN-107**

DIRECT OPERATED SPOOL TYPE

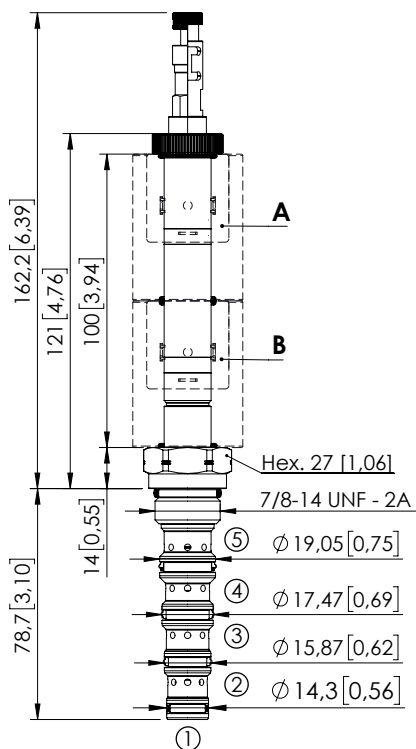

Dimensions: mm [inches]

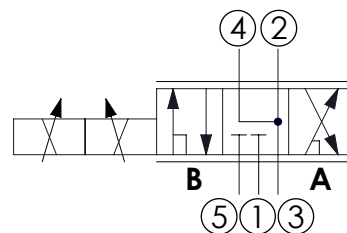

**SPECIFICATIONS**

Max. operating pressure:	350 bar (5000 psi)
Max. operating pressure on port 1:	210 bar (3000 psi)
Rated flow:	30 l/min (8 gpm)
Cavity:	SAE 10 5N
Weight:	0.22 kg (0.68 lbs)
Min. voltage required:	90% of nominal
Coil type:	M16
Ambient temperature:	-20/+50 °C (-4/+122 °F)
PWM range recommended:	100 Hz
Contamination class to ISO 4406:	See technical spec.
Seal kit:	RB900107
Installation torque:	55 - 62 Nm (41 - 46 ft-lb)
MTTF:	150 - 1200 years: See technical spec.
Leakage:	120 cm <sup>3</sup> /min (@46 cSt) 7.3 in <sup>3</sup> /min (@46 cSt)

**NOTES**

For other configurations/quick codes not available in this catalogue page please consult factory

**OPTIONS**

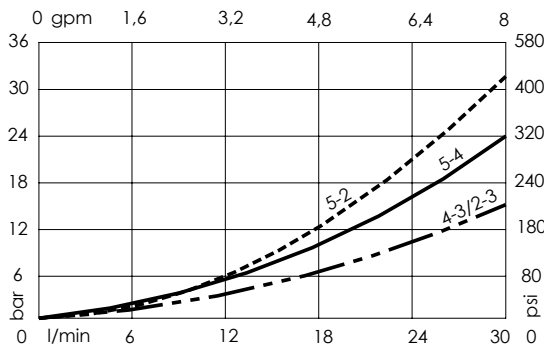

**ORDERING CODES**

Quick code	Description	Options
CE001865	CEFS-030-SEPN-107-S10-N350	Standard
CE001866	CEFS-030-SEPL-107-S10-N350	Push and pull manual override
CE001867	CEFS-030-SEPG-107-S10-N350	Push pull and twist manual override



SOLENOID OPERATED CARTRIDGE

**CEFS-030-SEPN-108**

DIRECT OPERATED  
SPOOL TYPE

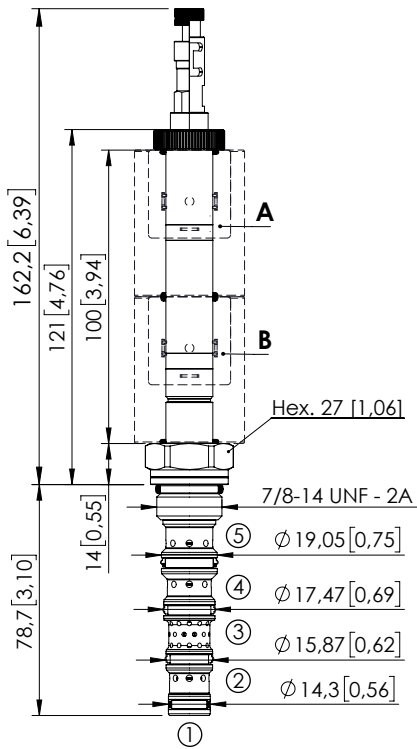

Dimensions: mm [inches]

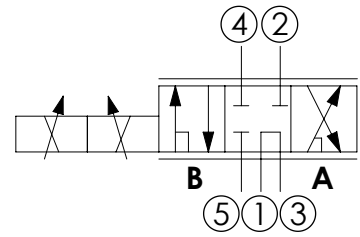

**SPECIFICATIONS**

Max. operating pressure:	350 bar (5000 psi)
Max. operating pressure on port 1:	210 bar (3000 psi)
Rated flow:	30 l/min (8 gpm)
Cavity:	SAE 10 5N
Weight:	0,22 kg (0,68 lbs)
Min. voltage required:	90% of nominal
Coil type:	M16
Ambient temperature:	-20/+50 °C (-4/+122 °F)
PWM range recommended:	100 Hz
Contamination class to ISO 4406:	See technical spec.
Seal kit:	RB900107
Installation torque:	55 - 62 Nm (41 - 46 ft-lb)
MTF <sub>d</sub> :	150 - 1200 years: See technical spec.
Leakage:	120 cm <sup>3</sup> /min (@46 cSt) 7,3 in <sup>3</sup> /min (@46 cSt)

**NOTES**

For other configurations/quick codes not available in this catalogue page please consult factory

**OPTIONS**

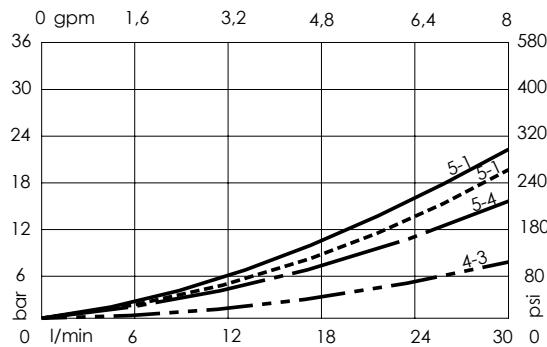

**ORDERING CODES**

Quick code	Description	Options
CE001868	CEFS-030-SEPN-108-S10-N350	Standard
CE001869	CEFS-030-SEPL-108-S10-N350	Push and pull manual override
CE001870	CEFS-030-SEPG-108-S10-N350	Push pull and twist manual override

Revision A

PROPORTIONAL VALVE CONTROLLER

**ELPC-030-SCCB**

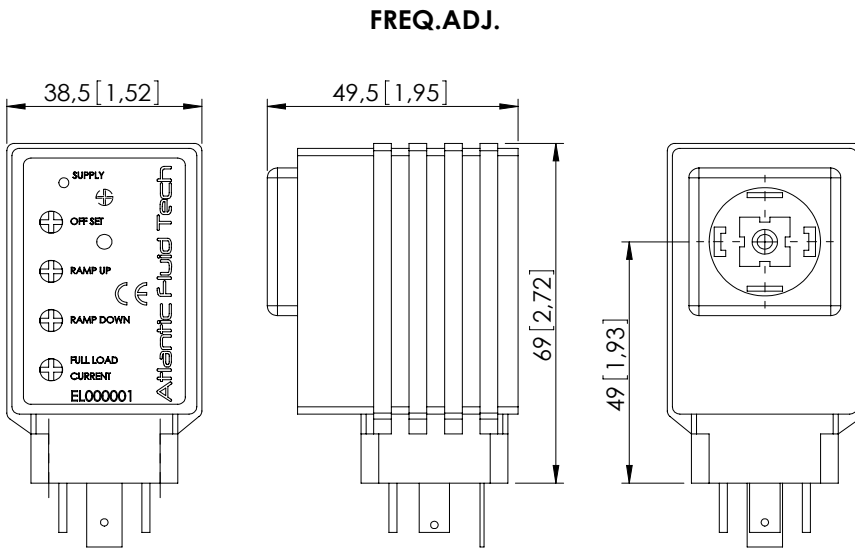
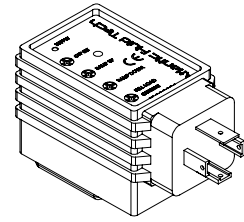

Max torque 0,5 Nm [0,37 ft-lb]

**SPECIFICATIONS**

**Supply voltage: 12 - 30 VDC**  
Coil rating must be matched with supply voltage:  
 $R_{coil} < (V_{supply} - 1,5V) / I_{max}$

**Control input signal options:**  
**5KΩ external potentiometer**  
(accepts 2KΩ to 10KΩ), or 0-10 VDC signal  
(see connection diagram)

**Output current: up to 2A**

**Minimum current: 0 - 0,6 A**

**Max current deviation in temperature range: 3%**

**Ramp up / ramp down: 0,1 to 10 sec**  
Ramp setting independent from current range

**PWM frequency: 100 - 500 Hz**

**Operating conditions: -20 TO +70°C**  
0 to 85% relative humidity

**Environmental protection: IP65**  
with cover and seals installed

**Connector type: DIN 43650 - ISO 4400**

**CONNECTION EXAMPLE WITH JOYSTICK OR POTENTIOMETER**

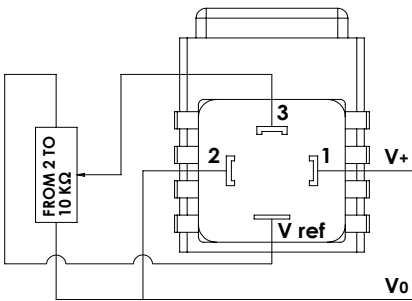

**CONNECTION EXAMPLE WITH ANALOGIC SIGNAL**

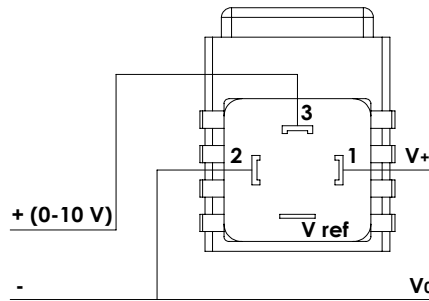

**IMPORTANT**

**DO NOT REMOVE controller from solenoid when energized to avoid the risk of damaging it**

**SETTING INSTRUCTIONS**

**SUPPLY:** led is on when current is supplied

**OFFSET:** to be used to set minimum current value (l/min-gpm), turn clockwise to increase setting

**RAMP UP:** to be used to set the ramp time from minimum (l/min-gpm) to maximum current value (l max-g max)

**RAMP DOWN:** to be used to set the ramp time from maximum (l max-g max) to minimum current value (l/min-gpm)

**FULL LOAD CURRENT:** to be used to set maximum current value (l max-g max), turn clockwise to increase setting

**FREQ. ADJ.:** this trimmer is inside the controller and is preset by factory, to be used to modify the PWM frequency

**ORDERING CODES**

Quick code	Description
EL000001	Proportional controller ELPC-030-SCCB

For other configurations/quick codes not available in this catalogue page please consult factory