

SOLENOID OPERATED CARTRIDGE

CEBN-060-XCDR-31

POPPET TYPE
PROXIMITY SENSOR

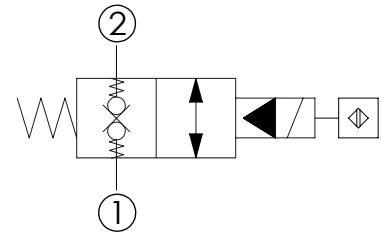
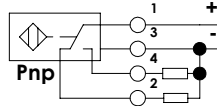
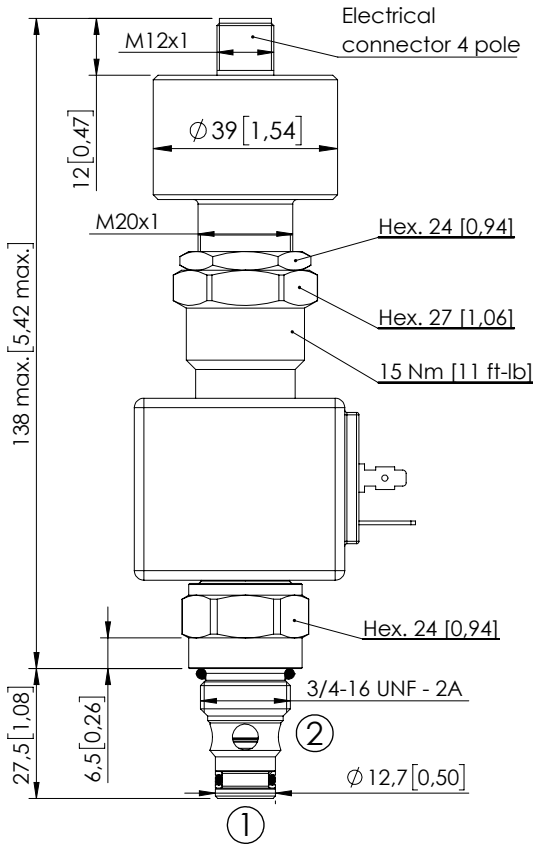

SPECIFICATIONS

Max. operating pressure:	350 bar (5000 psi)
Rated flow:	60 l/min (16 gpm)
Cavity:	SAE-08-2N
Weight:	0,51 kg (0,33 lbs)
Min. voltage required:	90% of nominal
Coil type:	M7 type
Ambient temperature:	-20/+50 °C (-4/+122 °F)
Contamination class to ISO 4406:	See technical spec.
Seal kit:	RB100081
Installation torque:	45 - 50 Nm (33 - 37 ft-lb)
MTF _d :	150 - 1200 years: See technical spec.
Operating temperature:	-25/+80°C (-13/+176 °F)

NOTES

For other configurations/quick codes not available in this catalogue page please consult factory

CURVES

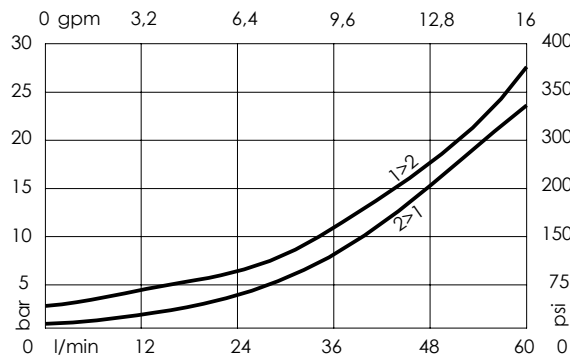

ORDERING CODES

Quick code	Description	Connector	Voltage	Options
CE001035	CEBN-060-XCDR-31-S08-V350-12HR	DIN 43650	12V DC	Proximity sensor
CE001064	CEBN-060-XCDR-31-S08-V350-24HR	DIN 43650	24V DC	Proximity sensor