

SOLENOID OPERATED CARTRIDGE

**CEBD-001-NAFN-13**

DIRECT OPERATED  
POPPET TYPE

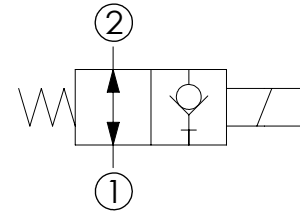
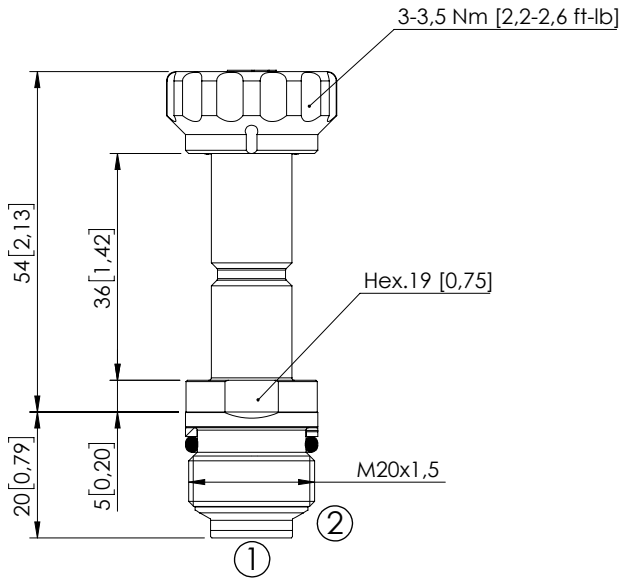

**SPECIFICATIONS**

Max. operating pressure:	350 bar (5000 psi)
Rated flow:	1 l/min (0,3 gpm)
Cavity:	VP000445
Weight:	0,1 kg (0,3 lbs)
Min. voltage required:	90% of nominal
Coil type:	M7 or M3 type
Ambient temperature:	-20/+50 °C (-4/+122 °F)
Contamination class to ISO 4406:	See technical spec.
Seal kit:	RC700445
Installation torque:	40 - 45 Nm (30 - 33 ft-lb)
MTF <sub>d</sub> :	150 - 1200 years: See technical spec.

Dimensions: mm [inches]

**NOTES**

For other configurations/quick codes not available in this catalogue page please consult factory

**CURVES**

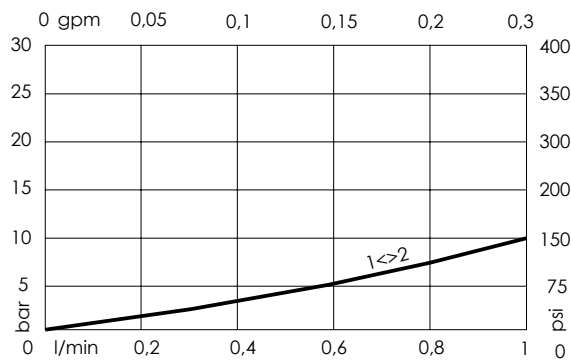

**ORDERING CODES**

Quick code	Description	Options	Max operating pressure
CE000872	CEBD-001-NAFN-13-445-N350	Standard	350 bar (5000 psi)