

SOLENOID OPERATED CARTRIDGE

CEBD-001-NCFN-16

DIRECT OPERATED
POPPET TYPE

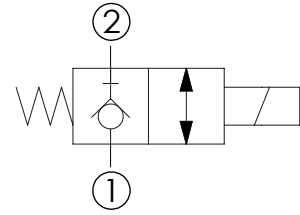
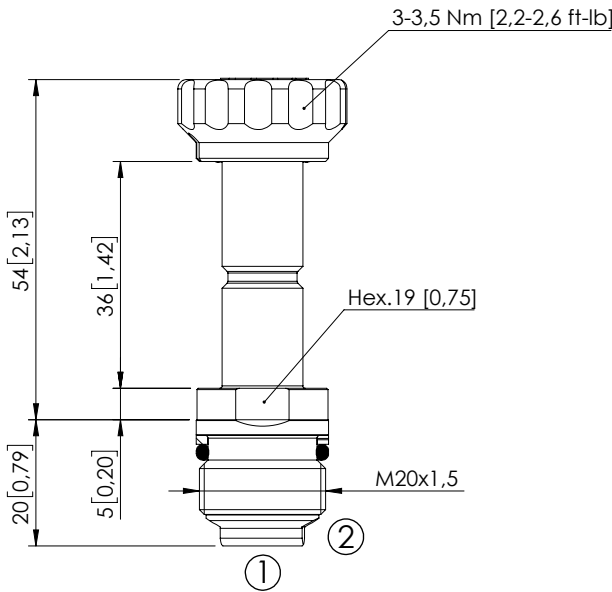

SPECIFICATIONS

Max. operating pressure:	350 bar (5000 psi)
Rated flow:	1 l/min (0,3 gpm)
Cavity:	VP000445
Weight:	0,1 kg (0,3 lbs)
Min. voltage required:	90% of nominal
Coil type:	M7 or M3 type
Ambient temperature:	-20/+50 °C (-4/+122 °F)
Contamination class to ISO 4406:	See technical spec.
Seal kit:	RC700445
Installation torque:	40 - 45 Nm (30 - 33 ft-lb)
MTF _d :	150 - 1200 years: See technical spec.

Dimensions: mm [inches]

NOTES

For other configurations/quick codes not available in this catalogue page please consult factory

CURVES

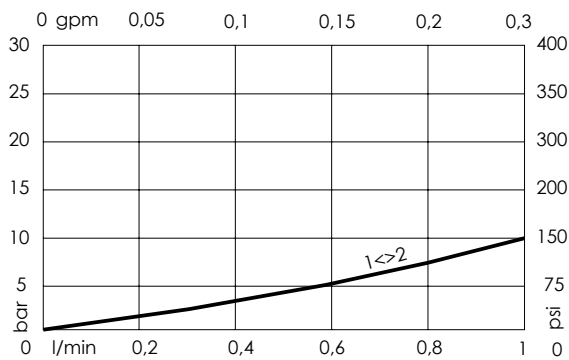

ORDERING CODES

Quick code	Description	Options	Max operating pressure
CE000871	CEBD-001-NCFN-16-445-N350	Standard	350 bar (5000 psi)