

SOLENOID OPERATED CARTRIDGE

CEBN-310-NAFN-02

PILOT OPERATED
POPPET TYPE

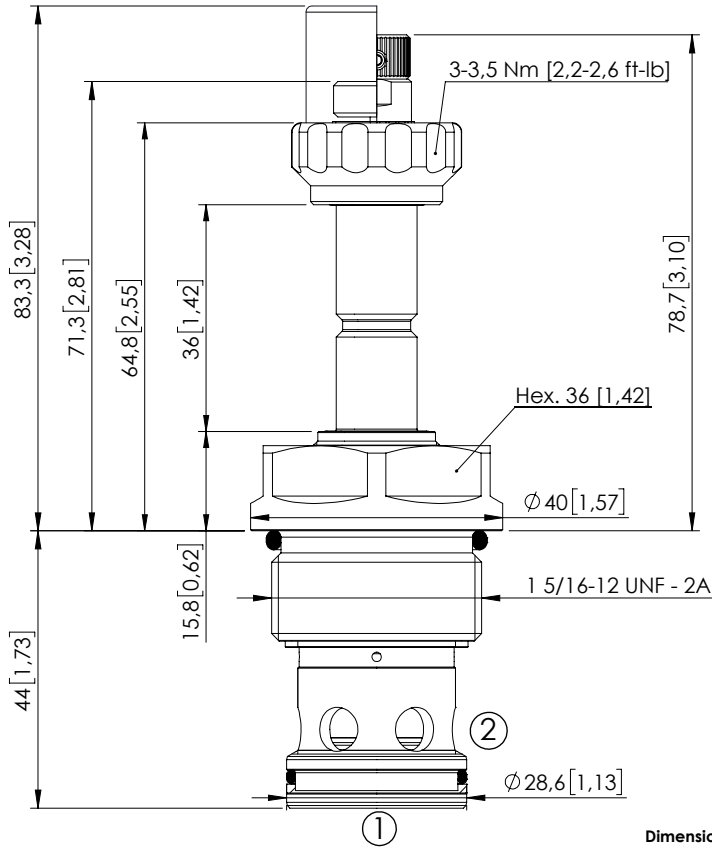

Dimensions: mm [inches]

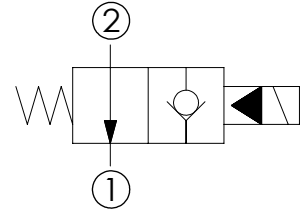

SPECIFICATIONS

Max. operating pressure:	350/500 bar (5000/7200 psi)
Rated flow:	310 l/min (82 gpm)
Cavity:	SAE-16-2N
Weight:	0,36 kg (0,79 lbs)
Min. voltage required:	90% of nominal
Coil type:	M7 or M3 type
Ambient temperature:	-20/+50 °C (-4/+122 °F)
Contamination class to ISO 4406:	See technical spec.
Seal kit:	RA900084
Installation torque:	200 - 210 Nm (148 - 155 ft-lb)
MTF _d :	150 - 1200 years: See technical spec.

NOTES

For other configurations/quick codes not available in this catalogue page please consult factory

CURVES

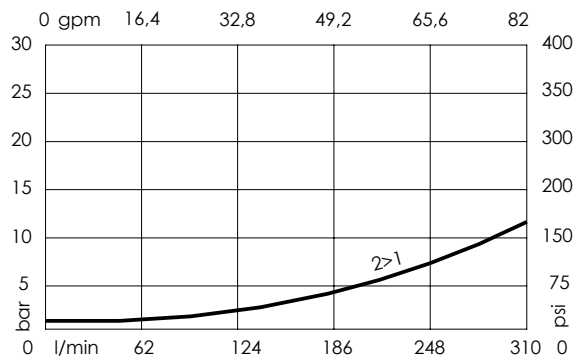

OPTIONS

Standard	
Push style override	
Knob style override	

SEALING CAP

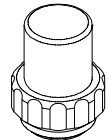

Ordering code:
AT000113

ORDERING CODES

Quick code	Description	Options	Max operating pressure
CE000405	CEBN-310-NAFN-02-S16-N350	Standard	350 bar (5000 psi)
CE000406	CEBN-310-NAFP-02-S16-N350	Push style override	350 bar (5000 psi)
CE000407	CEBN-310-NAFK-02-S16-N350	Knob style override	350 bar (5000 psi)
CE000705	CEBN-310-NAFN-02-S16-N500	Standard	500 bar (7200 psi)
CE000706	CEBN-310-NAFP-02-S16-N500	Push style override	500 bar (7200 psi)
CE000707	CEBN-310-NAFK-02-S16-N500	Knob style override	500 bar (7200 psi)