

SOLENOID OPERATED CARTRIDGE

CEBN-190-NAFN-06

PILOT OPERATED
POPPET TYPE

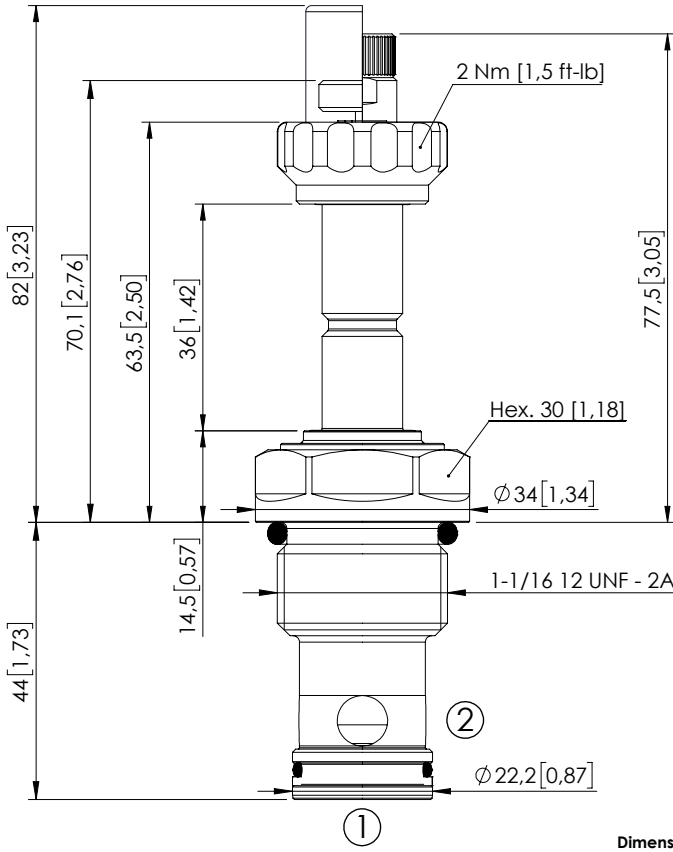

Dimensions: mm [inches]

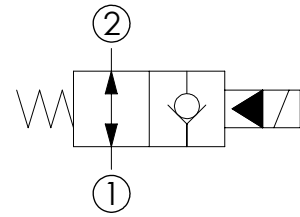

SPECIFICATIONS

Max. operating pressure:	350/500 bar (5000/7200 psi)
Rated flow:	190 l/min (50 gpm)
Cavity:	SAE-12-2N
Weight:	0,25 kg (0,55 lbs)
Min. voltage required:	90% of nominal
Coil type:	M7 or M3 type
Ambient temperature:	-20/+50 °C (-4/+122 °F)
Contamination class to ISO 4406:	See technical spec.
Seal kit:	RA900083
Installation torque:	135 - 150 Nm (100 - 111 ft-lb)
MTF _d :	150 - 1200 years: See technical spec.

NOTES

For other configurations/quick codes not available in this catalogue page please consult factory

CURVES

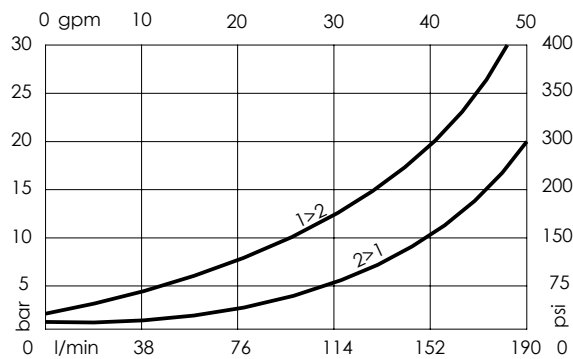

OPTIONS

Standard



Push style override



Knob style override



SEALING CAP

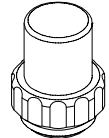

Ordering code:
AT000113

ORDERING CODES

Quick code	Description	Options	Max operating pressure
CE000341	CEBN-190-NAFN-06-S12-N350	Standard	350 bar (5000 psi)
CE000342	CEBN-190-NAFP-06-S12-N350	Push style override	350 bar (5000 psi)
CE000343	CEBN-190-NAFK-06-S12-N350	Knob style override	350 bar (5000 psi)
CE000641	CEBN-190-NAFN-06-S12-N500	Standard	500 bar (7200 psi)
CE000642	CEBN-190-NAFP-06-S12-N500	Push style override	500 bar (7200 psi)
CE000643	CEBN-190-NAFK-06-S12-N500	Knob style override	500 bar (7200 psi)