

SOLENOID OPERATED CARTRIDGE

**CEBN-080-NAFN-06**

PILOT OPERATED  
POPPET TYPE

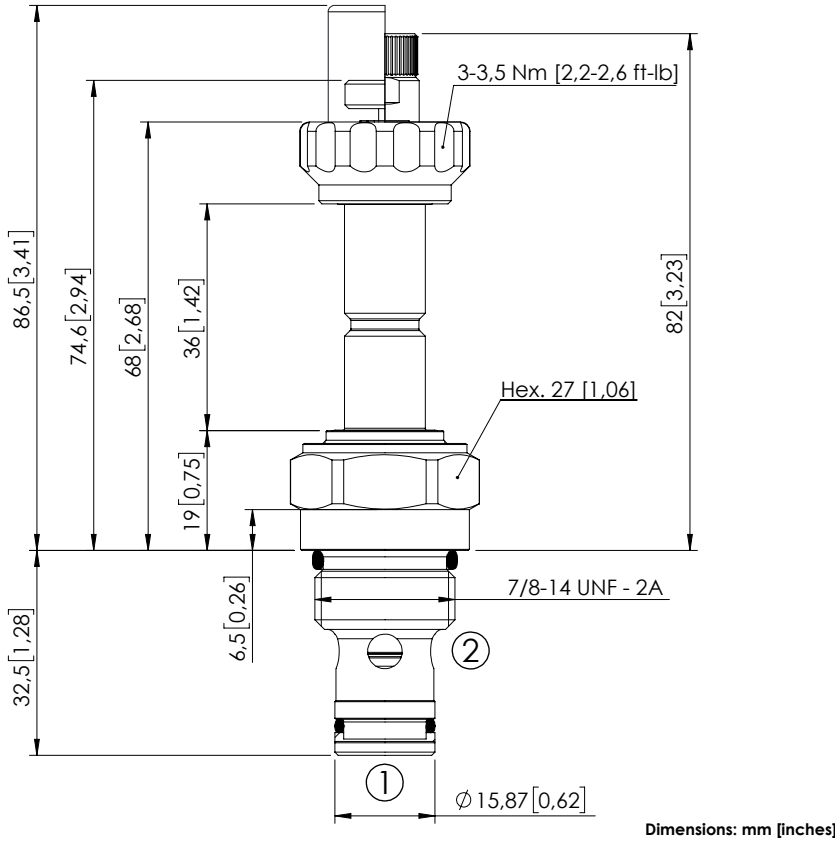

Dimensions: mm [inches]

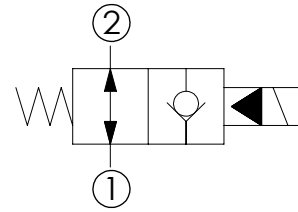

**SPECIFICATIONS**

Max. operating pressure:	350/500 bar (5000/7200 psi)
Rated flow:	80 l/min (21 gpm)
Cavity:	SAE-10-2N
Weight:	0,18 kg (0,40 lbs)
Min. voltage required:	90% of nominal
Coil type:	M7 or M3 type
Ambient temperature:	-20/+50 °C (-4/+122 °F)
Contamination class to ISO 4406:	See technical spec.
Seal kit:	RA900082
Installation torque:	55 - 62 Nm (41 - 46 ft-lb)
MTF <sub>d</sub> :	150 - 1200 years: See technical spec.



**NOTES**

For other configurations/quick codes not available in this catalogue page please consult factory

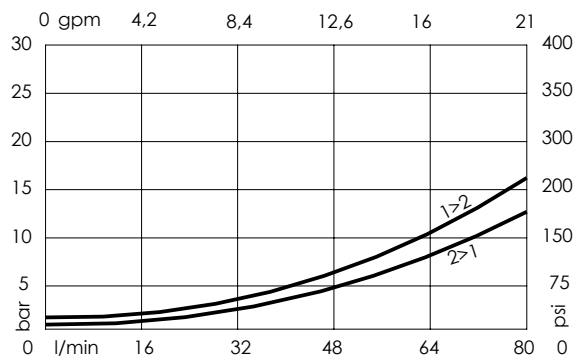
**CURVES**



**OPTIONS**

- Standard 
- Push style override 
- Knob style override 

**SEALING CAP**

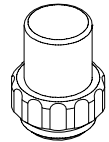

Ordering code:  
AT000113

**ORDERING CODES**

Quick code	Description	Options	Max operating pressure
CE000271	CEBN-080-NAFN-06-S10-N350	Standard	350 bar (5000 psi)
CE000272	CEBN-080-NAFP-06-S10-N350	Push style override	350 bar (5000 psi)
CE000273	CEBN-080-NAFK-06-S10-N350	Knob style override	350 bar (5000 psi)
CE000571	CEBN-080-NAFN-06-S10-N500	Standard	500 bar (7200 psi)
CE000572	CEBN-080-NAFP-06-S10-N500	Push style override	500 bar (7200 psi)
CE000573	CEBN-080-NAFK-06-S10-N500	Knob style override	500 bar (7200 psi)