

SOLENOID OPERATED CARTRIDGE

CEBN-060-NAFN-06

PILOT OPERATED
POPPET TYPE

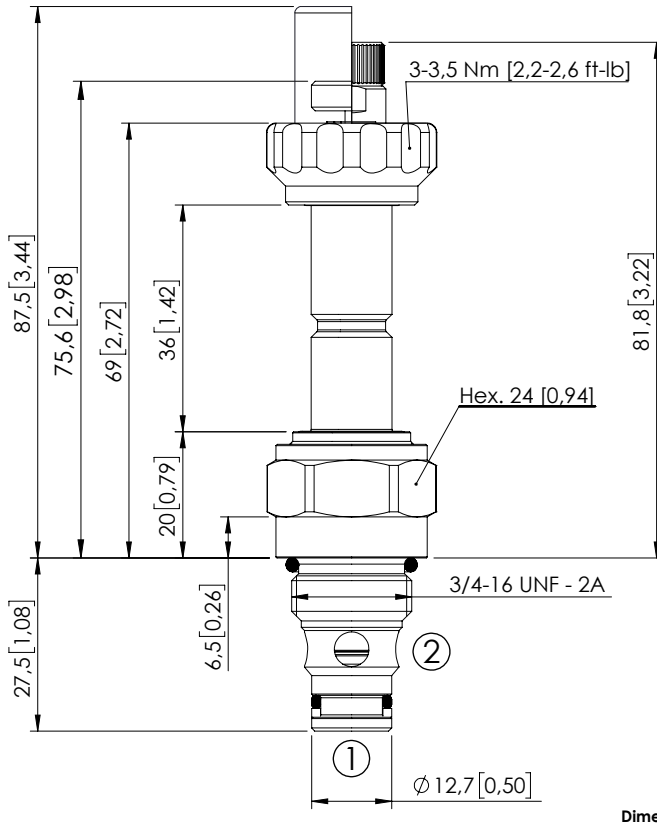

Dimensions: mm [inches]

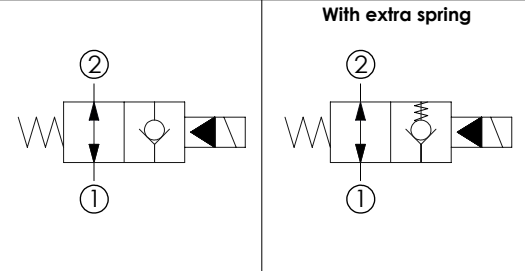

SPECIFICATIONS



Max. operating pressure:	350/500 bar (5000/7200 psi)
Rated flow:	60 l/min (16 gpm)
Cavity:	SAE-08-2N
Weight:	0,15 kg (0,33 lbs)
Min. voltage required:	90% of nominal
Coil type:	M7 or M3 type
Ambient temperature:	-20/+50 °C (-4/+122 °F)
Contamination class to ISO 4406:	See technical spec.
Seal kit:	RA900081
Installation torque:	45 - 50 Nm (33 - 37 ft-lb)
MTF _d :	150 - 1200 years: See technical spec.

NOTES

For other configurations/quick codes not available in this catalogue page please consult factory

CURVES

OPTIONS

- Standard 
- Push style override 
- Knob style override 

SEALING CAP

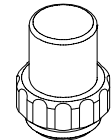

Ordering code:
AT000113

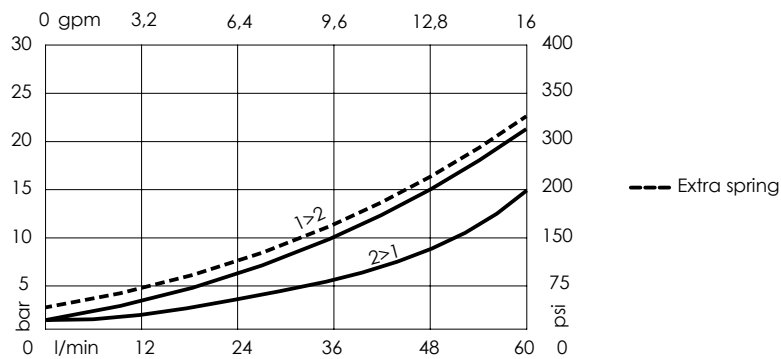

ORDERING CODES

Quick code	Description	Options	Max operating pressure	Extra Spring
CE000236	CEBN-060-NAFN-06-S08-N350	Standard	350 bar (5000 psi)	No
CE000237	CEBN-060-NAFP-06-S08-N350	Push style override	350 bar (5000 psi)	No
CE000238	CEBN-060-NAFK-06-S08-N350	Knob style override	350 bar (5000 psi)	No
CE000483	CEBN-060-XAFN-06-S08-N350	Standard	350 bar (5000 psi)	Yes
CE000536	CEBN-060-NAFN-06-S08-N500	Standard	500 bar (7200 psi)	No
CE000537	CEBN-060-NAFP-06-S08-N500	Push style override	500 bar (7200 psi)	No
CE000538	CEBN-060-NAFK-06-S08-N500	Knob style override	500 bar (7200 psi)	No