

SOLENOID OPERATED CARTRIDGE

**CEBD-001-NCFN-15**

DIRECT OPERATED  
POPPET TYPE

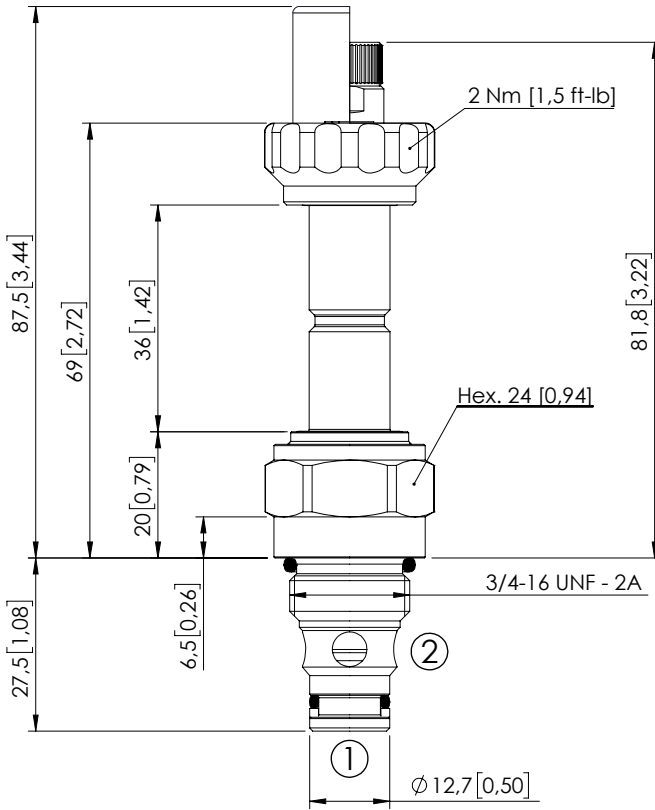

Dimensions: mm [inches]

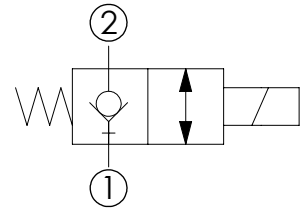

**SPECIFICATIONS**

Max. operating pressure:	350/500 bar (5000/7200 psi)
Rated flow:	1,5 l/min (0,4 gpm)
Cavity:	SAE-08-2N
Weight:	0,15 kg (0,33 lbs)
Min. voltage required:	90% of nominal
Coil type:	M7 or M3 type
Ambient temperature:	-20/+50 °C (-4/+122 °F)
Contamination class to ISO 4406:	See technical spec.
Seal kit:	RA900081
Installation torque:	45 - 50 Nm (33 - 37 ft-lb)
MTF <sub>d</sub> :	150 - 1200 years: See technical spec.

**NOTES**

For other configurations/quick codes not available in this catalogue page please consult factory

**CURVES**

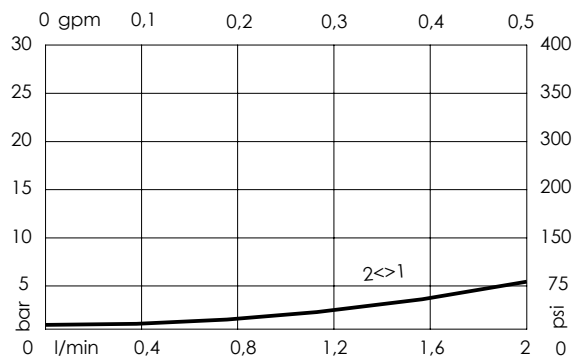

**OPTIONS**

Standard



Knob style override



**SEALING CAP**

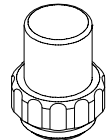

Ordering code:  
AT000113

**ORDERING CODES**

Quick code	Description	Options	Max operating pressure
CE000200	CEBD-001-NCFN-15-S08-N350	Standard	350 bar (5000 psi)
CE000201	CEBD-001-NCFK-15-S08-N350	Knob style override	350 bar (5000 psi)
CE000500	CEBD-001-NCFN-15-S08-N500	Standard	500 bar (7200 psi)
CE000501	CEBD-001-NCFK-15-S08-N500	Knob style override	500 bar (7200 psi)