

SOLENOID OPERATED CARTRIDGE

CECS-015-SEFN-61

DIRECT OPERATED
SPOOL TYPE

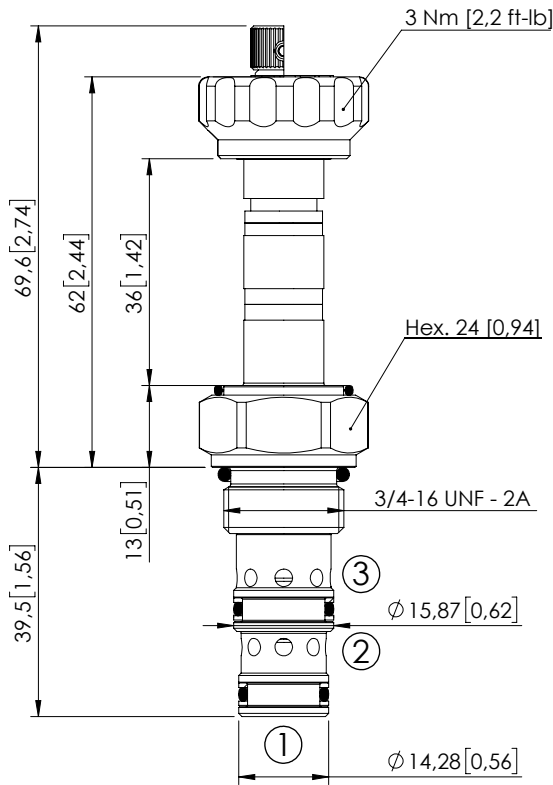

Dimensions: mm [inches]

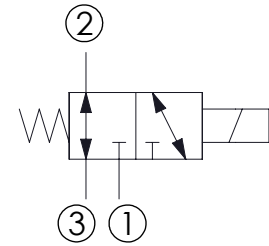

SPECIFICATIONS

Max. operating pressure:	350 bar (5000 psi)
Max. operating pressure on port 1:	280 bar (4000 psi)
Rated flow:	15 l/min (4 gpm)
Cavity:	SAE-08-3N
Weight:	0,14 kg (0,26 lbs)
Min. voltage required:	90% of nominal
Coil type:	M7 or M3 type
Ambient temperature:	-20/+50 °C (-4/+122 °F)
Contamination class to ISO 4406:	See technical spec.
Seal kit:	RB700091
Installation torque:	45 - 50 Nm (33 - 37 ft-lb)
MTF _a :	150 - 1200 years: See technical spec.
Leakage:	120 cm ³ /min (@46 cSt) 7,3 in ³ /min (@46 cSt)

NOTES

For other configurations/quick codes not available in this catalogue page please consult factory

OPTIONS

Standard



Knob style override



CURVES

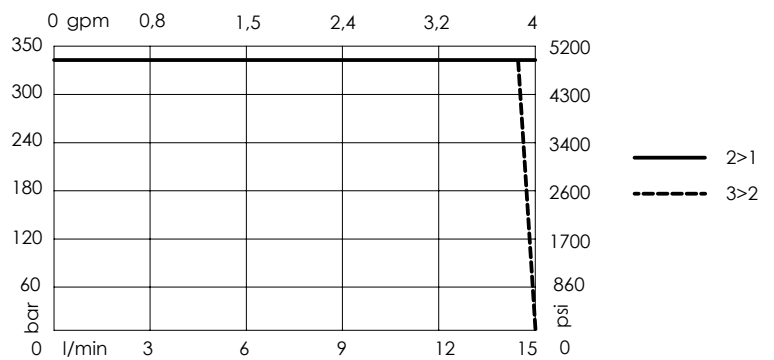
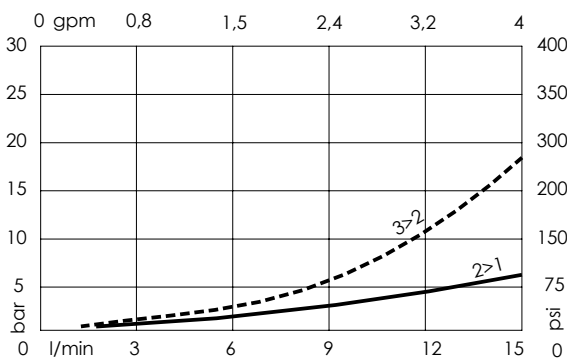

ORDERING CODES

Quick code	Description	Options
CE000009	CECS-015-SEFN-61-S08-N350	Standard
CE000066	CECS-015-SEFE-61-S08-N350	Knob style override