

COIL

COIL SERIES M11

DIN 43650 - ISO 4400
CLASS H

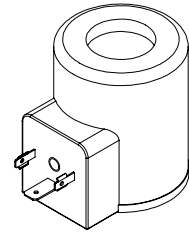
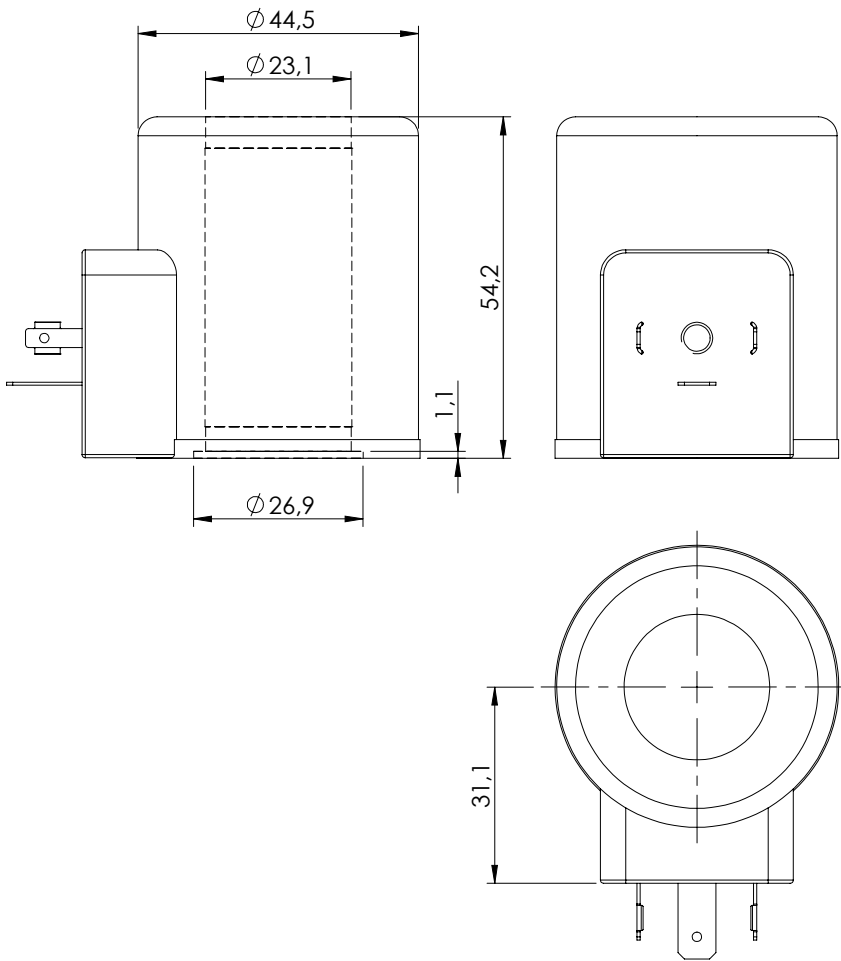

SPECIFICATIONS

Heat insulation class H	180°C
Ambient temperature	-30 + 60°C
Inlet voltage	±10% tol.
Insulation class IP69K with all seals properly mounted	
Weight:	0,18 kg

NOTES

ORDERING CODES

Quick code	Description	Connector type	Voltage (V)	Resistance (Ω) ±7%	Power (w)	Current (A)
AB000149	Coil M11 HS 12V CLASS H	DIN 43650-ISO 4400	12 DC	3.27	44	3.67
AB000150	Coil M11 HS 24V CLASS H	DIN 43650-ISO 4400	24 DC	13.09	44	1.83