

SOLENOID OPERATED CARTRIDGE

CEES-010-SEFN

**DIRECT OPERATED
SPOOL TYPE**

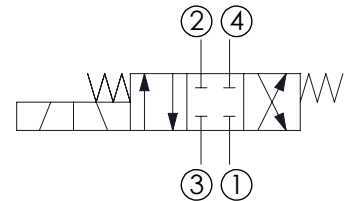
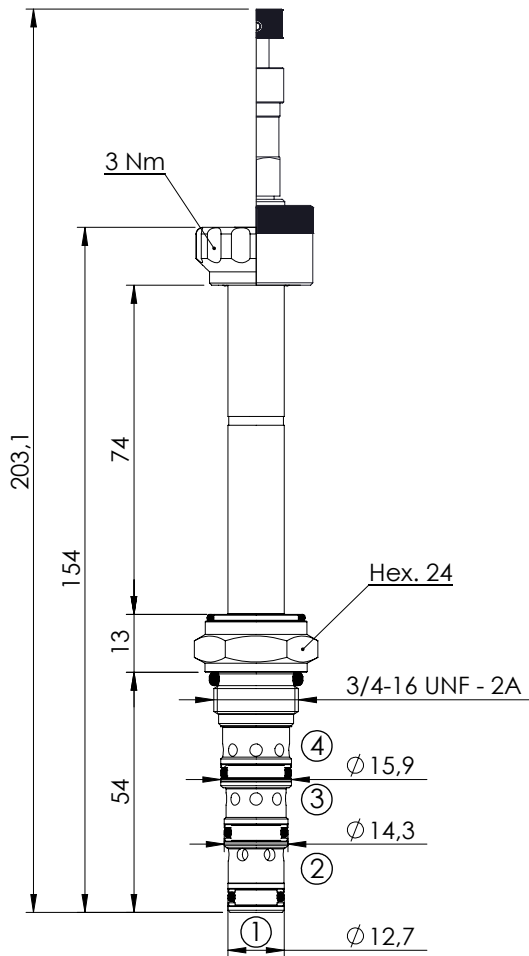

SPECIFICATIONS

Max. operating pressure:	210 bar
Rated flow:	10 l/min
Cavity:	SAE-08-4N
Weight:	0,18 kg
Min. voltage required:	90% of nominal
Coil type:	M7 type
Leakage:	120cm ³ /min
Seal kit:	RB700101

NOTES

Installation torque: 45 - 50 Nm

OPTIONS



Standard

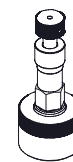

Push and pull manual override

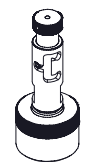

Push pull and twist manual override

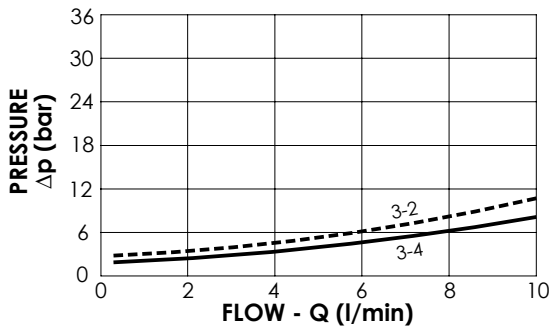

ORDERING CODES

Quick code	Description	Options	
CE000028	CEES-010-SEFN-51-S08-N210	Standard	
CE000098	CEES-010-SEFL-51-S08-N210	Push and pull manual override	
CE000189	CEES-010-SEFG-51-S08-N210	Push pull and twist manual override	