

SOLENOID OPERATED CARTRIDGE

CEDS-010-SEFN

**DIRECT OPERATED
SPOOL TYPE**

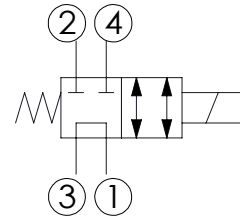
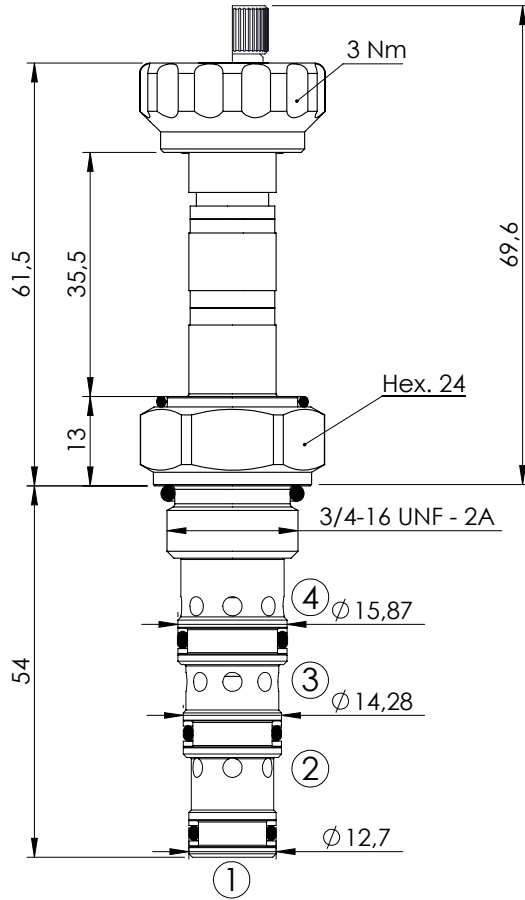

SPECIFICATIONS

Max. operating pressure:	210 bar
Rated flow:	10 l/min
Cavity:	SAE-08-4N
Weight:	0,14 kg
Min. voltage required:	90% of nominal
Coil type:	M7 type
Leakage:	120cm ³ /min
Seal kit:	RB700101

NOTES

Installation torque: 45 - 50 Nm

OPTIONS

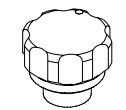

Standard

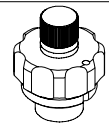

Knob style
override

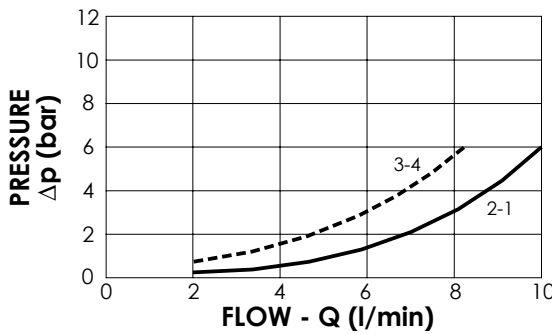

ORDERING CODES

Quick code	Description	Options	
CE000006	CEDS-010-SEFN-43-S08-N210	Standard	
CE000074	CEDS-010-SEFE-43-S08-N210	Knob style override	