

**SOLENOID OPERATED CARTRIDGE**

**CEBN-070-NCFN**

**PILOT OPERATED  
POPPET TYPE**

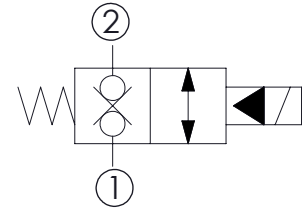
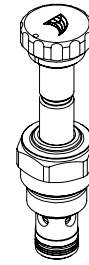
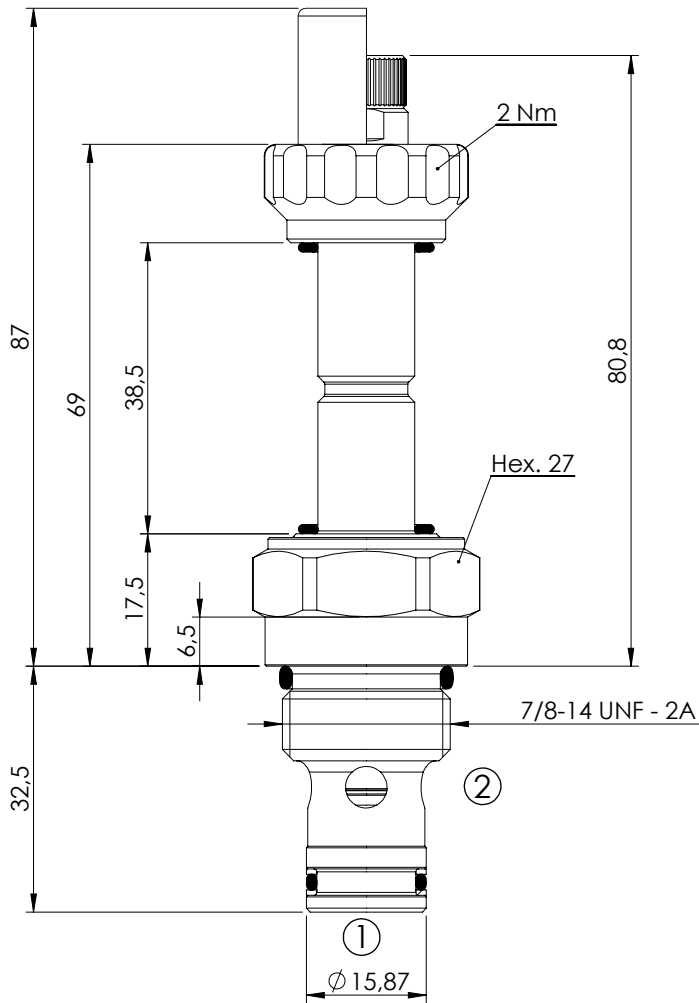

**SPECIFICATIONS**

Max. operating pressure:	350/500 bar
Rated flow:	70 l/min
Cavity:	SAE-10-2N
Weight:	0,18 kg
Min. voltage required:	90% of nominal
Coil type:	M7 type
Seal kit:	RB900082

**NOTES**

Installation torque: 55 - 62 Nm

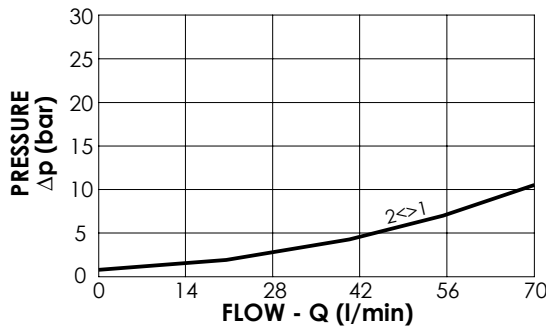

**OPTIONS**

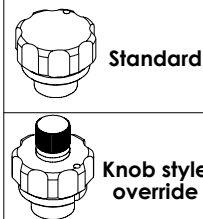

**SEALING CAP**

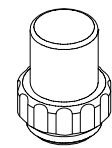

Ordering code:  
AT000113

**ORDERING CODES**

Quick code	Description	Options	Max operating pressure (bar)
CE000261	CEBN-070-NCFN-31-S10-N350	Standard	350
CE000263	CEBN-070-NCFK-31-S10-N350	Knob style override	350
CE000561	CEBN-070-NCFN-31-S10-N500	Standard	500
CE000563	CEBN-070-NCFK-31-S10-N500	Knob style override	500