

SOLENOID OPERATED CARTRIDGE

CEBN-180-NAFN

**PILOT OPERATED
POPPET TYPE**

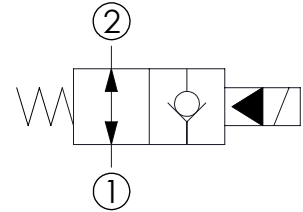
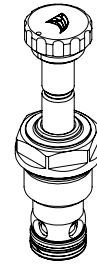
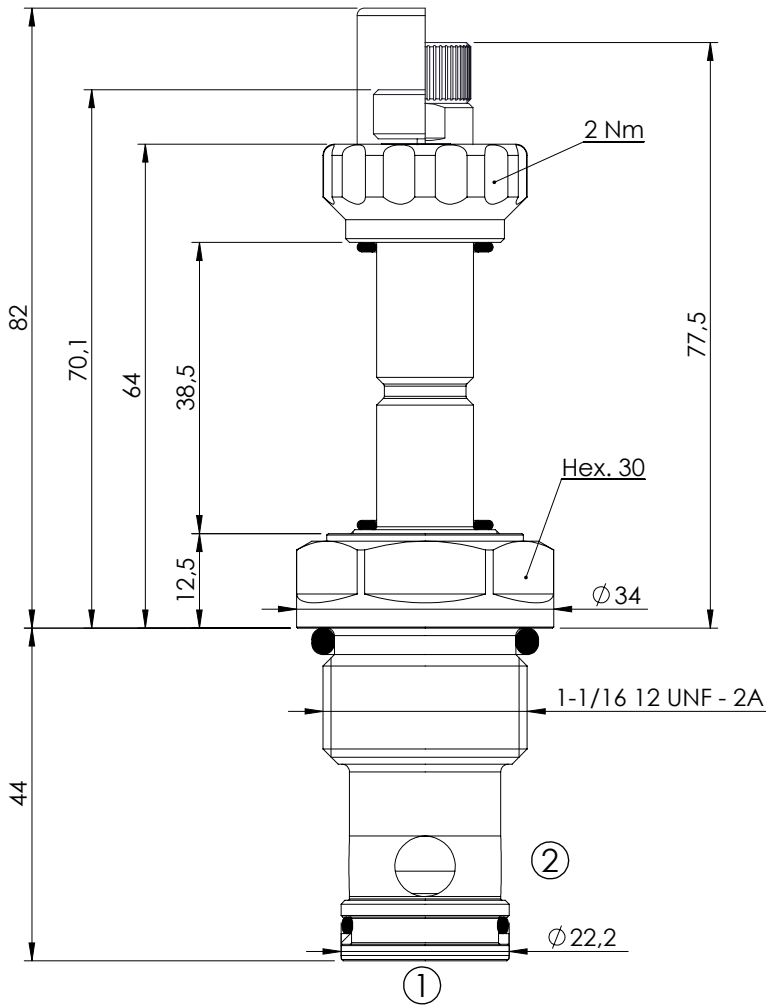

SPECIFICATIONS

Max. operating pressure:	350/500 bar
Rated flow:	180 l/min
Cavity:	SAE-12-2N
Weight:	0,25 kg
Min. voltage required:	90% of nominal
Coil type:	M7 type
Seal kit:	RA900083

NOTES

Installation torque: 135 - 150 Nm

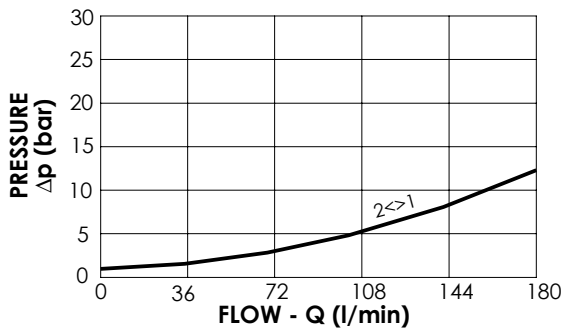

OPTIONS

- Standard
- Push style override
- Knob style override

SEALING CAP

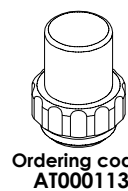

ORDERING CODES

Quick code	Description	Options	Max operating pressure (bar)
CE000341	CEBN-180-NAFN-06-S12-N350	Standard	350
CE000342	CEBN-180-NAFP-06-S12-N350	Push style override	350
CE000343	CEBN-180-NAFK-06-S12-N350	Knob style override	350
CE000641	CEBN-180-NAFN-06-S12-N500	Standard	500
CE000642	CEBN-180-NAFP-06-S12-N500	Push style override	500
CE000643	CEBN-180-NAFK-06-S12-N500	Knob style override	500