

SOLENOID OPERATED CARTRIDGE

CEBN-030-NAFN

**PILOT OPERATED
POPPET TYPE**

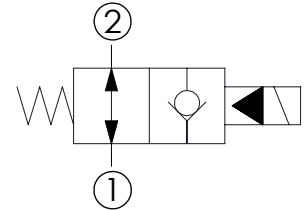
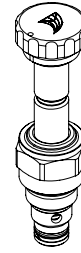
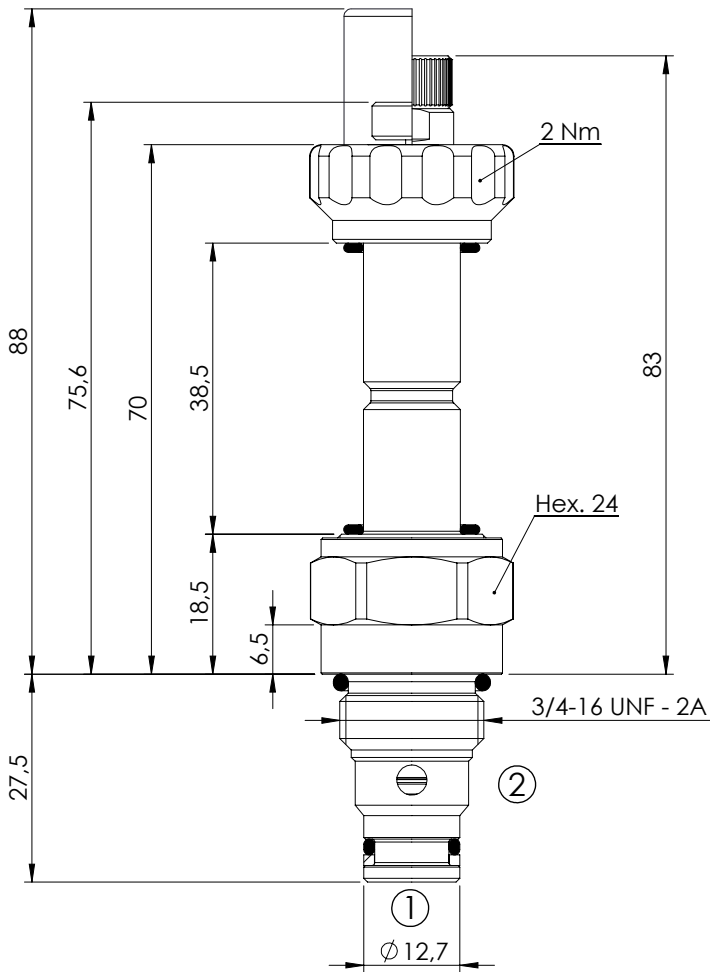

SPECIFICATIONS

Max. operating pressure:	350 bar
Rated flow:	30 l/min
Cavity:	SAE-08-2N
Weight:	0,15 kg
Min. voltage required:	90% of nominal
Coil type:	M7 type
Seal kit:	RA900081

NOTES

Installation torque: 45 - 50 Nm

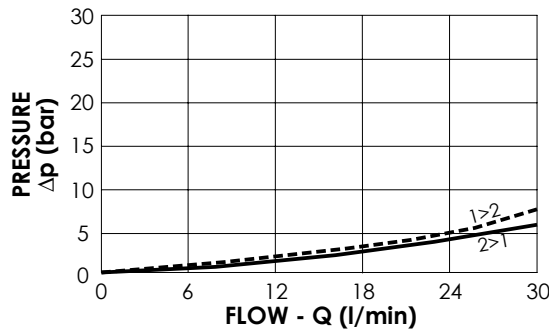

OPTIONS

- Standard
- Push style override
- Knob style override

SEALING CAP

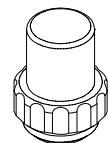

Ordering code:
AT000113

ORDERING CODES

Quick code	Description	Options	Max operating pressure (bar)
CE000464	CEBN-030-NAFN-06-S08-N350	Standard	350
CE000465	CEBN-030-NAFP-06-S08-N350	Push style override	350
CE000466	CEBN-030-NAFK-06-S08-N350	Knob style override	350